

User Manual

MUH44TPR2-N

4K HDBaseT 4x4 Matrix Switcher



All Rights Reserved

Version: MUH44TPR2-N_2016V1.1

Preface

Read this user manual carefully before using this product. Pictures shown in this manual is for reference only, different model and specifications are subject to real product.

This manual is only for operation instruction only, not for any maintenance usage. The functions described in this version are updated till May 2016. Any changes of functions and parameters since then will be informed separately. Please refer to the dealers for the latest details.

All product function is valid till 2016-5-23.

Trademarks

Product model, PTN and its logo  are trademarks of PTN Electronics Limited. Any other trademarks mentioned in this manual are acknowledged as the properties of the trademark owner. No part of this publication may be copied or reproduced without the prior written consent of PTN Electronics Limited.

FCC Statement

This equipment generates, uses and can radiate radio frequency energy and, if not installed and used in accordance with the instructions, may cause harmful interference to radio communications. It has been tested and found to comply with the limits for a Class B digital device, pursuant to part 15 of the FCC Rules. These limits are designed to provide reasonable protection against harmful interference in a commercial installation.

Operation of this equipment in a residential area is likely to cause interference, in which case the user at their own expense will be required to take whatever measures may be necessary to correct the interference

Any changes or modifications not expressly approved by the manufacture would void the user's authority to operate the equipment.



SAFETY PRECAUTIONS

To insure the best from the product, please read all instructions carefully before using the device. Save this manual for further reference.

- Unpack the equipment carefully and save the original box and packing material for possible future shipment
- Follow basic safety precautions to reduce the risk of fire, electrical shock and injury to persons.
- Do not dismantle the housing or modify the module. It may result in electrical shock or burn.
- Using supplies or parts not meeting the products' specifications may cause damage, deterioration or malfunction.
- Refer all servicing to qualified service personnel.
- To prevent fire or shock hazard, do not expose the unit to rain, moisture or install this product near water.
- Do not put any heavy items on the extension cable in case of extrusion.
- Do not remove the housing of the device as opening or removing housing may expose you to dangerous voltage or other hazards.
- Install the device in a place with fine ventilation to avoid damage caused by overheat.
- Keep the module away from liquids.
- Spillage into the housing may result in fire, electrical shock, or equipment damage. If an object or liquid falls or spills on to the housing, unplug the module immediately.
- Do not twist or pull by force ends of the optical cable. It can cause malfunction.
- Do not use liquid or aerosol cleaners to clean this unit. Always unplug the power to the device before cleaning.
- Unplug the power cord when left unused for a long period of time.
- Information on disposal for scrapped devices: do not burn or mix with general household waste, please treat them as normal electrical wastes.

Contents

1. Introduction.....	1
1.1 Introduction to the MUH44TPR2-N.....	1
1.2 Features	1
1.3 Package List	2
2. Product Appearance of the MUH44TPR2-N	3
2.1 Front Panel.....	3
2.2 Rear Panel.....	4
3. System Connection.....	6
3.1 System Applications.....	6
3.2 Usage Precautions	6
3.3 Connection Diagram	6
3.4 Connection Procedure	7
3.5 Connection with TPHD402PR.....	7
4. System Operations	8
4.1 Front Panel Button Control	8
4.1.1 Switching I/O connection	8
4.1.2 EDID Management	8
4.1.3 Inquiry.....	10
4.1.4 Clear operation	11
4.2 IR Control	11
4.2.1 Usage of IR Remote	11
4.2.2 Force Carrier	12
4.2.3 Control Far-end Device locally.....	12
4.2.4 Control Local Device Remotely	13
4.3 RS232 Control	14
4.3.1 Connection with RS232 Communication Port.....	14
4.3.2 Control through 9-pin RS232 port.....	15
4.3.3 Control through 3-pin RS232 port.....	15
4.3.4 Installation/uninstallation of RS232 Control Software	16
4.3.5 Basic Settings.....	16
4.3.6 RS232 Communication Commands	17

4.4 TCP/IP Control.....	23
4.4.1 Control Modes	23
4.4.2 GUI for TCP/IP control.....	25
4.4.3 GUI Update.....	27
4.5 Firmware Update via USB	28
5. Specification.....	29
6 Panel Drawing	30
7. Troubleshooting & Maintenance	32
8. After-sales Service.....	34

1. Introduction

1.1 Introduction to the MUH44TPR2-N

MUH44TPR2-N is a professional 4x4 HDBaseT Matrix Switcher that accommodates 4 HDMI IN (4k signal at max), 4 auxiliary audio IN, 4 IR IN.

Select HDMI input by front panel buttons, IR, RS232, or GUI. The selected source is delivered to HDMI Output 1~2 (for HDMI input 1~2) & HDBaseT outputs 1~4 (easy extension to 70m at 1080p and 40m at 4Kx2K on a single CAT5e/6 connection with HDBaseT receivers, with PoC) simultaneously. The unit also supports EDID management and HDCP.

Except embedded HDMI audio, MUH44TPR2-N provides 4 auxiliary audio outputs. Audio source is selectable via RS232 command. Selected audio is output via HDMI outputs & HDBaseT outputs and the audio output sockets.

The unit also supports bi-directional RS232 & IR control.

1.2 Features

- Support HDMI 1.4 & HDCP2.2, and compliant with lower standards, capable to transmit 4Kx2K@60Hz & 1080p 3D
- Support manual HDCP management and auto-detecting
- Transmit 4Kx2K signal for 8m via HDMI port, 40m via HDBT port
- Audio source selectable via RS232 command
- 4 HDBaseT outputs, for easy extension to 70m at 1080p and 40m at 4Kx2K on a single CAT5e/6 cable
- Support PoC
- LCD screen shows real-time I/O connection status, switching status, HDCP status, and output resolution.
- Controllable via front panel, RS232, IR and TCP/IP
- Support bi-directional IR & RS232 control
- Built-in GUI for TCP/IP control
- Powerful EDID management
- Support off memory for reliable operation
- Support firmware upgrade through Micro USB port
- Easy installation with rack-mounting design

1.3 Package List

- 1 x MUH44TPR2-N
- 2 x Mounting ears (6 x Screws)
- 1 x RS232 cable
- 1 x IR Receiver
- 4 x Plastic cushions (4 x Black Screws)
- 1 x IR remote
- 1 x Power Adapter (DC 24V 2.71A)
- 8 x Pluggable Terminal Blocks
- 1 x User manual

Notes: Confirm if the product and the accessories are all included, if not, please contact with the dealers.

2. Product Appearance of the MUH44TPR2-N

2.1 Front Panel

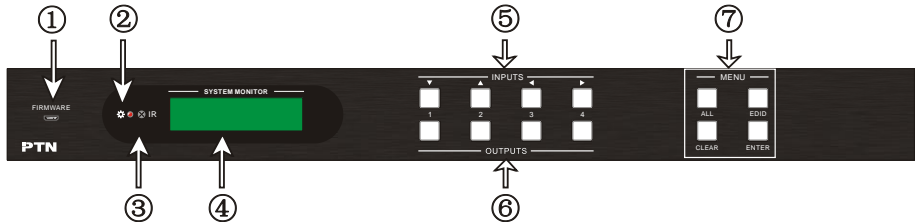

No.	Name	Description
①	Firmware	Micro USB port for updating firmware
②	Power Indicator	Illuminate red when power on.
③	IR	In-built IR sensor, receive IR signals sent from IR remote.
④	LCD Screen	Display real-time operation status.
⑤	INPUTS/ Menu buttons	<ul style="list-style-type: none"> ➢ Normal mode: Back-lit buttons, ranging from "1" to "4". ➢ Inquiry mode (buttons 1~4): Press "ENTER" for more than 3 seconds to enter this mode. Dial ◀▶ to select different menus, ▲▼ to select different options.
⑥	OUTPUTS buttons/ EDID Management buttons	<ul style="list-style-type: none"> ➢ Normal mode: Back-lit buttons, ranging from "1" to "4". Output 1~2 support synchronous local HDMI output. ➢ EDID Invoking mode: press and hold EDID button for 3 seconds or more to enter this mode, in this mode, button 1, 2 are used to switch to the previous/ next EDID data.
⑦	Function buttons	<p>ALL: Select all inputs/ outputs.</p> <p>EDID management button: Enable input port to manually capture and learn the EDID data of output devices.</p> <p>CLEAR: Withdraw an operation like switching output channel, learning EDID data before it comes into effect. Meanwhile, the matrix will return to the previous status.</p> <p>ENTER: Confirm operation. Press and hold it for 3 seconds to enter in Inquiry mode.</p>

Notes: Pictures shown in this manual are for reference only, different model and specifications are subject to real product.

2.2 Rear Panel

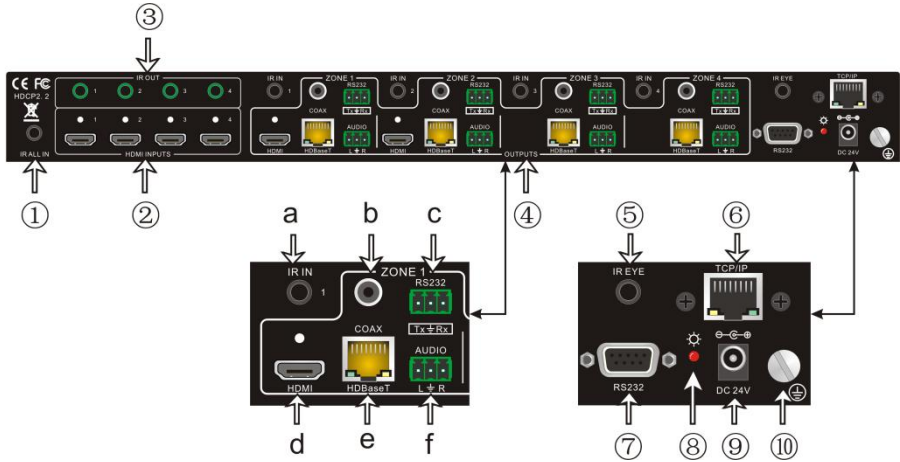

No.	Name	Description
①	IR ALL IN	Input port for IR control signal, connect with IR receiver, deliver IR signal to all the HDBaseT ports to control the remote devices.
②	HDMI INPUTS	HDMI input ports, 4 in total, type A female HDMI connector, connect with HDMI input source devices.
③	IR OUT	Connect with IR transmitter, to emit the IR signal sent from the HDBaseT ports of the far-end Receiver. These IR OUT sockets make up an IR matrix with the IR IN sockets on the HDBaseT receivers, and all IR signals can be switched synchronously with the AV signal, or separately switched.
④	OUTPUTS	<p>a. IR IN: Connect with IR receiver, fixed IR input for the output, cannot be switched separately. It makes up an IR bi-directional transmission with the IR OUT on the corresponding HDBaseT receiver.</p> <p>b. COAX: HDMI de-embedded digital audio output.</p> <p>c. RS232: Serial port to communicate with the RS232 port on corresponding HDBaseT receiver. When controlled by HDBaseT receiver, the communication protocol must be the same with MUH44TPR2-N.</p> <p>d. HDMI: HDMI output port, connect with HDMI displays, deliver same input signals with HDBaseT ports, split HDMI output for local monitoring.</p> <p>e. HDBaseT: Works with HDBaseT receivers, such as</p>

		<p>TPHD402PR. It can extend AV, IR and RS232 signal to 70m distance. Meanwhile, it can provide power for the receivers which support PoC.</p> <p>f. AUDIO: HDMI de-embedded stereo audio output</p>
⑤	IR EYE	Connect with extended IR receiver, use the IR remote to control MUH44TPR2-N.
⑥	TCP/IP	TCP/IP port for unit control
⑦	RS232	Serial port for unit control, 9-pin female connector, connects with control device such as a PC.
⑧	Power Indicator	Illuminate red when powered on.
⑨	DC 24V	Connect with DC 24V power adaptor.
⑩	GROUND	Connect to grounding, make the unit ground well.

Note: Pictures shown in this manual are for reference only, different model and specifications are subject to real product.

3. System Connection

3.1 System Applications

As its good performance in control and transmission, the MUH44TPR2-N can be widely used in computer realm, monitoring, large screen displaying, conference system, television education and bank securities institutions etc.

3.2 Usage Precautions

- 1) System should be installed in a clean environment and has a prop temperature and humidity.
- 2) All of the power switches, plugs, sockets and power cords should be insulated and safe.
- 3) All devices should be connected before power on.

3.3 Connection Diagram

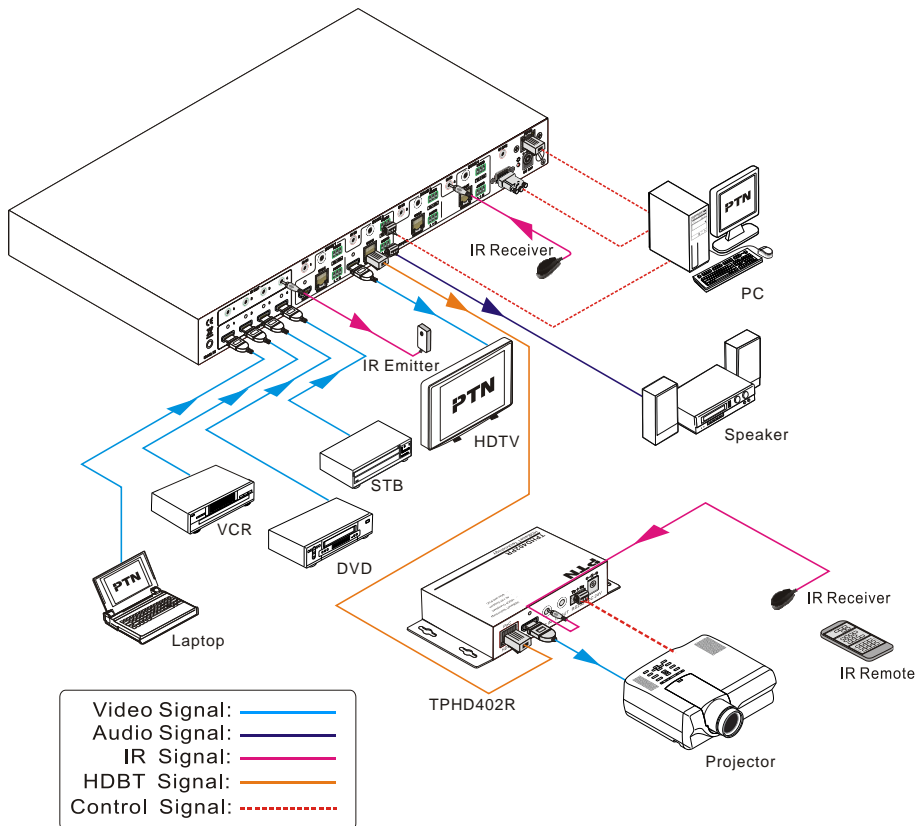

3.4 Connection Procedure

- 1) Connect HDMI sources (e.g. DVD) to HDMI inputs of the MUH44TPR2-N with HDMI cables.
- 2) Connect auxiliary audio sources to the AUDIO IN ports with audio cables.
- 3) Connect HDBaseT receivers (e.g. TPHD402PR) to the HDBaseT Output ports with twisted pair.
- 4) Connect HDMI displays (e.g. HDTV) to HDMI outputs of the MUH44TPR2-N or the receivers with HDMI cables
- 5) Connect speakers/earphones to AUDIO output ports
- 6) Connect the RS232 port of control device (e.g. a PC) to the RS232 port of either MUH44TPR2-N or far-end receivers. RS232 signal can be transmitted bi-directionally between MUH44TPR2-N and far-end receivers.
- 7) MUH44TPR2-N can collect IR signal sent by the included IR remote via its built-in IR sensor or through external IR receiver connected to the IR IN/ IR EYE/ IR ALL IN port. The IR signal can be transmitted bi-directionally between MUH44TPR2-N and far-end receivers.
- 8) Connect a DC 24V power adapter and the MUH44TPR2-N.

Note:

1. Connect HDBT ports of MUH44TPR2-N and far-end receiver with straight-through cable.
2. IR receivers connected to IR IN& IR ALL IN should be with carrier. If not, send command %0900. or %0901. to activate native carrier mode or force carrier mode in the IR matrix launched between MUH44TPR2-N and far-end receivers.

3.5 Connection with TPHD402PR

MUH44TPR2-N boasts 4 HDBaseT output ports which support PoC solution. Connect the HDBT output ports of MUH44TPR2-N to HDBaseT Receivers supporting PoC (like TPHD402PR) via twisted pair. Plug a power supply to the power port of MUH44TPR2-N, the HDBaseT Receivers will be energized synchronously with PoC solution.

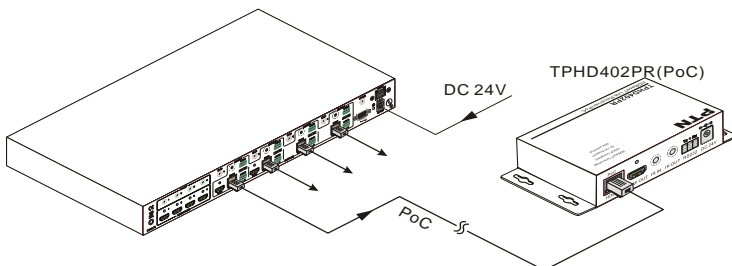

4. System Operations

4.1 Front Panel Button Control

MUH44TPR2-N provides with convenient front panel button control. Here we make a brief introduction to the system operations.

4.1.1 Switching I/O connection

1) To convert one input to an output:

Operation: “input”+“output”+“ENTER”

Example: input 1 to output 2

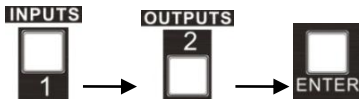

Note: In default status, 4 IR OUT sockets correspond with 4 HDMI INPUTS. When you convert an HDMI input to an output, the corresponding IR OUT will be switched synchronously.

2) To convert an input to several outputs:

Operation: “input” + “output” + “output” + ... + “ENTER”

Example: Switch input 2 to output 2, 4

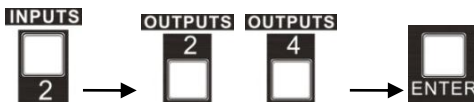

3) To convert an input to all outputs:

Operation: “input” + “ALL” + “ENTER”

Example: Convert input 1 to all outputs

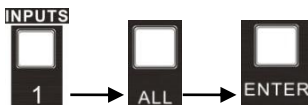

Note: Indicators of the pressed buttons will blink green for three times if the conversion is done, then it will be off. If the conversion failed, they will be off immediately.

4.1.2 EDID Management

MUH44TPR2-N features EDID management to maintain compatibility between all devices. It can be controlled via EDID learning and EDID invoking.

EDID Learning (from output):

- One input port learns the EDID data of one output port
Operation: Press “EDID”, “INPUTS”+“OUTPUTS”+“ENTER”.

Example: Input 2 learns EDID data from output 4



- All input ports learn EDID data from one output port
Operation: Press “EDID”, “ALL”+“OUTPUTS”+“ENTER”

Example: All input ports learn EDID data from output 4

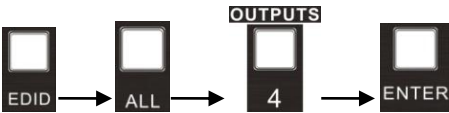

Note: Indicators of the pressed buttons will blink green for three times if the conversion is done, then it will be off. If the conversion failed, they will be off immediately.

EDID invoking:

There are five types of embedded EDID data. The chart below illustrates the detailed information of the embedded EDID data:

No.	EDID Data
1	1080P 2D 2CH
2	1080P 3D 2CH
3	1080P 2D Multichannel
4	1080P 3D Multichannel
5	3840x2160 2D (30Hz)

Press and hold “**EDID**” for 3 seconds to enter EDID invoking mode, in this mode, use output buttons 1/2 to switch among the 5 embedded EDID data. Then press “**ENTER**” to confirm invoking.

Format: Press and hold “EDID” for 3 seconds, “INPUTS”+“OUTPUTS 1/2”+“ENTER”.

Operations:

- Invoke embedded EDID data for one input

Operation: Press “EDID” (hold for 3 seconds to enter in EDID setting status), “INPUTS”+“OUTPUTS”+“ENTER”.

Example: Set the EDID data of INPUT 2 to the forth type of embedded EDID data:

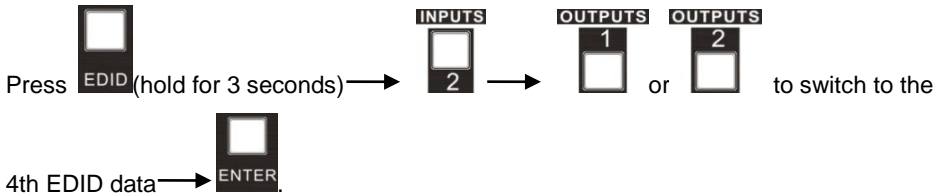

Note: If the conversion is successful, indicators of the pressed buttons will blink green for three times at normal speed; if the conversion failed, they will blink for three times quickly.

4.1.3 Inquiry

- Check status

Press and hold the button “ENTER” for 3 seconds, it will enter into system inquiry menu. Use Left and Right direction button to navigate checking the previous/next items.

Function Items	Example	Description
Check the connection status of inputs	<pre>In 01 02 03 04 Connct Y Y N N</pre>	Y means the corresponding port is connected with input device, N means not.
Check the connection status of outputs	<pre>Out 01 02 03 04 Connct Y Y N N</pre>	Y means the corresponding port is connected with output device, N means not.
Correspondence between inputs and outputs	<pre>Out 01 02 03 04 In 01 02 03 04</pre>	Shows the correspondence between the 4 inputs and 4 outputs.
Check if the input is with HDCP	<pre>In 01 02 03 04 HDCP Y Y N N</pre>	Y means the input signal is with HDCP, N means not.
Check if the output is with HDCP	<pre>Out 01 02 03 04 HDCP Y Y N N</pre>	Y means the output signal is with HDCP, N means not.
Check the output resolution	<pre>Resolution Out 1 1920x1080</pre>	Use the UP and DOWN direction button to check all the 4 output resolutions.

- Output check

Press any output button to check its corresponding input.

Example: Check which one is the corresponding input for output 2. (Presume Output 2 corresponds to Input 1.)

Operation: Press Output 2 button, LCD screen display “AV: 1->2 IR: 1->2”, and indicators of input 1 and output 2 turn on and last for 3 seconds. Then output 2 corresponds to input 1.

4.1.4 Clear operation

When you switch output channel, learn EDID data, or set EDID data, press **Clear** button to withdraw the operation before you press “**ENTER**” to carry it on. When you press it, the matrix will return to the previous status.

4.2 IR Control

By using IR & HDBaseT transmission technology, the MUH44TPR2-N has some functions as follows:

- 1) Control far-end output device from local.
- 2) Control local input/output device remotely.
- 3) Control the MUH44TPR2-N locally/remotely.

4.2.1 Usage of IR Remote



- ① Standby button, press it to enter/ exit standby mode
- ② Input channels, range from 1~4 (buttons 5~8 are not available), corresponding IR signal switched synchronously when switching input channels.
- ③ Menu buttons, **ALL**, **EDID** and **CLEAR**, same with the corresponding front panel buttons. Please refer to 4.1 *Front Panel Button Control* for details.
- ④ ▲▼◀▶: Navigation buttons.
ENTER: Confirm button.
- ⑤ OUTPUTS (buttons 5~8 are not available)
In normal mode: output channel selection buttons, each channel has 1 IR IN, 1 HDBaseT, 1 RS232, and 1 AUDIO outputs, and channel 1~4 have HDMI outputs.
In EDID invoking mode: press button 1/2 to switch among the 5 embedded EDID data

Note: With this IR remote, MUH44TPR2-N can be controlled by the built-in IR, the extended IR receiver connected to the “IR EYE”/“IR ALL IN” and the IR receiver on the far-end receiver.

4.2.2 Force Carrier

- a) Only if the IR receiver connected to HDBaseT receiver is with IR carrier, can the received IR signal be transferred to IR OUT port of the matrix.
- b) Only if the IR receiver connected to **IR ALL IN** port of the matrix is with IR carrier, can the received IR signal be transferred to IR OUT port of the matrix.

If the IR receiver connected with HDBaseT receiver or IR ALL IN port of the matrix is not with IR carrier, send the command “%0901.” to enter infrared carrier enforcing mode, and then IR signal can be transferred to IR OUT port.

4.2.3 Control Far-end Device locally

Connect an IR receiver to IR IN/ IR ALL IN on the switcher, and use the IR Remote of far-end device to control the device locally.

● **1 to 1: (through IR IN)**

Connect an IR receiver with IR carrier to the IR IN port of MUH44TPR2-N; users can control far-end output displayer via its IR remote from local.

In that case, the IR signal is transferred via twisted pair. Only the corresponding IR OUT port can emit control signals to the remote display.

See the figure below:

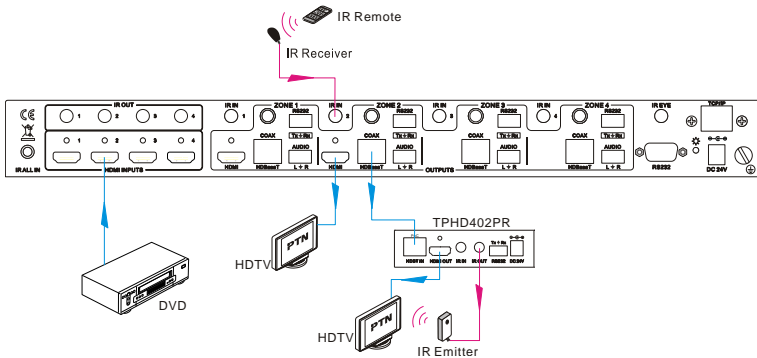

Control far-end device from Local

Note: The IR receiver connected to **IR IN** must be with IR carrier

● **1 to All: (through IR ALL IN)**

Connect an IR receiver to the IR ALL IN port of MUH44TPR2-N, the IR signal received from IR ALL IN port will be transmitted to all the 4 connected far-end HDBT receivers. See as below:

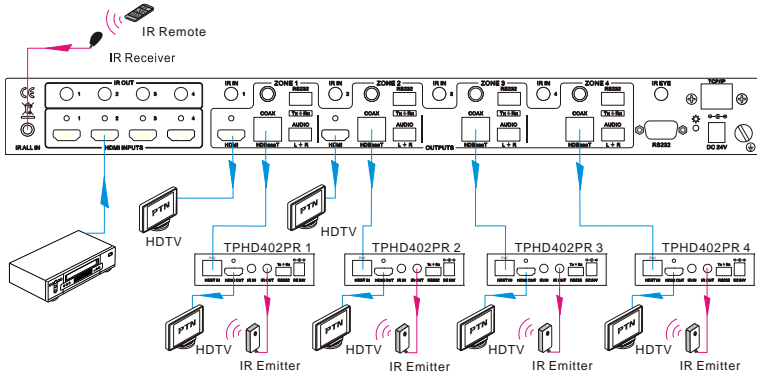

Control far-end device through IR ALL IN port

Note: Send command “%0901.” to enter infrared carrier enforcing mode if the IR Receiver connected to IR ALL IN is not with carrier.

4.2.4 Control Local Device Remotely

Connect IR receiver(s) to IR IN on far-end HDBT receiver(s), and IR Emitter(s) to IR OUT port of the switcher, and use the IR Remote of local source to control the device remotely.

- 1 to 1:

Connect an IR receiver to IR IN on far-end HDBT receiver, and an IR Emitter to IR OUT port of the switcher. Use the IR Remote of local source to control the device remotely. See below:

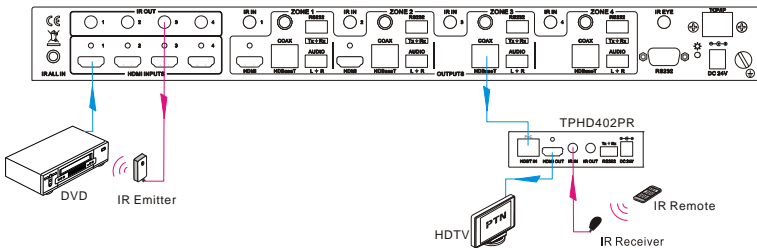

Control local device from remote

Note: Send command “%0901.” to enter infrared carrier enforcing mode if the IR Receiver connected to IR IN of the receiver is not with carrier.

- Multiple to Multiple: (IR Matrix)

The 4 “IR OUT” ports and the 4 “IR IN” ports on the far-end receivers make up a 4x4 IR matrix. See as below:

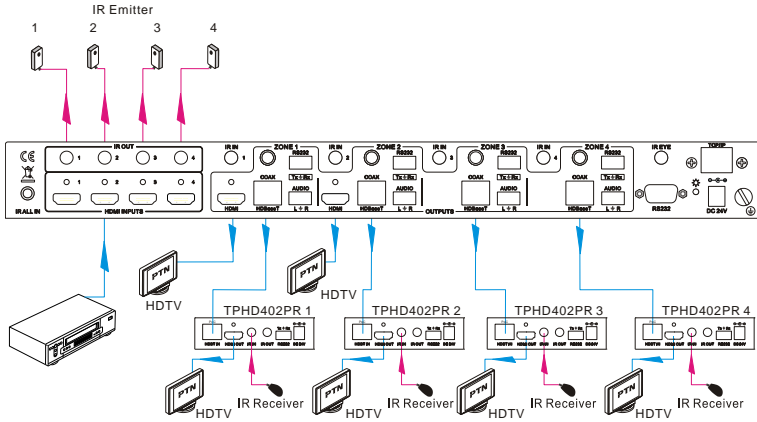

IR Matrix

The IR signal is sent by corresponding IR remote, then it is transferred to HDBaseT receiver, then to corresponding zone of the matrix through the twisted pair, finally it is transferred to IR OUT port and received by controlled device.

Switching Operation: (4 IR IN ports correspond with 4 HDMI input ports separately in default mode.)

a) Sending command (reference to 4.3 RS232 Control): [x1]R[x2].

x1: Corresponding to the 4 IR OUT ports of the matrix, the IR transmitter connected to this port can be placed at IR receiving area of output device or MUH44TPR2-N itself.

x2: Corresponding to the zone (receive IR signal from HDBaseT receiver with IR IN port connects with IR receiver) number of MUH44TPR2-N.

Example: Send command “3R2.” to transfer IR signal received from zone 2 to IR OUT port 3.

4.3 RS232 Control

4.3.1 Connection with RS232 Communication Port

Except the front control panel, the MUH44TPR2-N can be controlled by far-end control system through the RS232 communication port. This RS232 communication port is a female 9-pin D connector. The definition of its pins is listed in the table below.

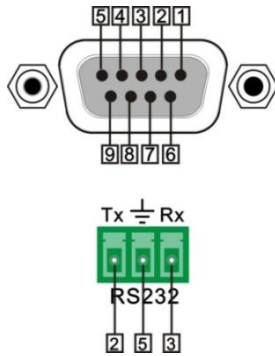

No.	Pin	Function
1	N/u	Unused
2	Tx	Transmit
3	Rx	Receive
4	N/u	Unused
5	Gnd	Ground
6	N/u	Unused
7	N/u	Unused
8	N/u	Unused
9	N/u	Unused

4.3.2 Control through 9-pin RS232 port

Connect a control device to the 9-pin RS232 port of the switcher; users are able to control the switcher & far-end device. See the figure below:

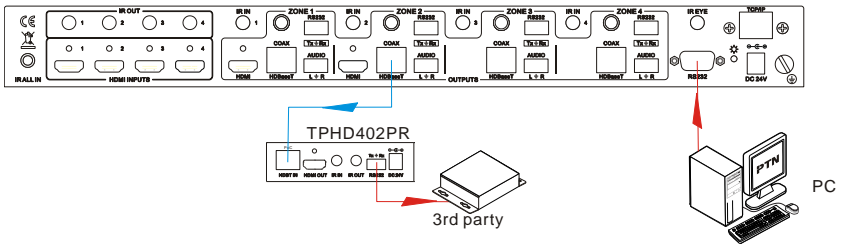

Control the switcher & 3rd-party Device through 9 pin female RS232 port

- Control the switcher: send RS232 commands directly
- Control 3rd party: send command: “+/+ [Y]/[X]:*****.” (Refer to for detailed information.)

4.3.3 Control through 3-pin RS232 port

- **Control 3rd party device from local**

Connect the RS232 (3-pin pluggable terminal block) port in any zone to PC, and connect the controlled RS232 device (3rd party device) to the corresponding (same zone as PC) receiver, see below:

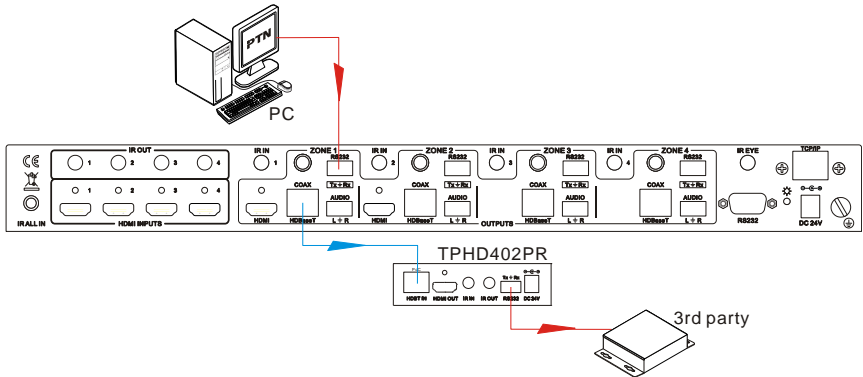

Control 3rd party device from local

● Control 3rd party device from remote

Connect the RS232 (3-pin pluggable terminal block) port in any zone to controlled device (3rd party device), and connect PC to the corresponding (same zone as controlled device) receiver, see below:

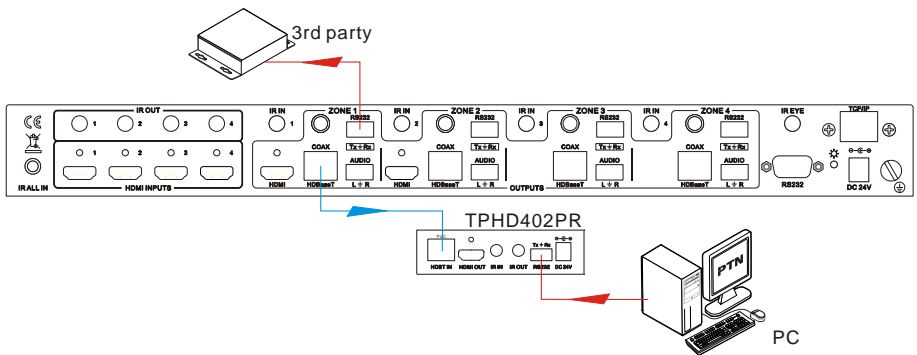

Control 3rd party device from remote

4.3.4 Installation/uninstallation of RS232 Control Software

- **Installation** Copy the control software file to the computer connected with MUH44TPR2-N.
- **Uninstallation** Delete all the control software files in corresponding file path.

4.3.5 Basic Settings

Firstly, connect MUH44TPR2-N with an input device and an output device. Then, connect it with a computer which is installed with RS232 control software. Double-click the software icon to run this software.

Here we take the software **CommWatch.exe** as example. The icon is showed as below:



The interface of the control software is showed as below:

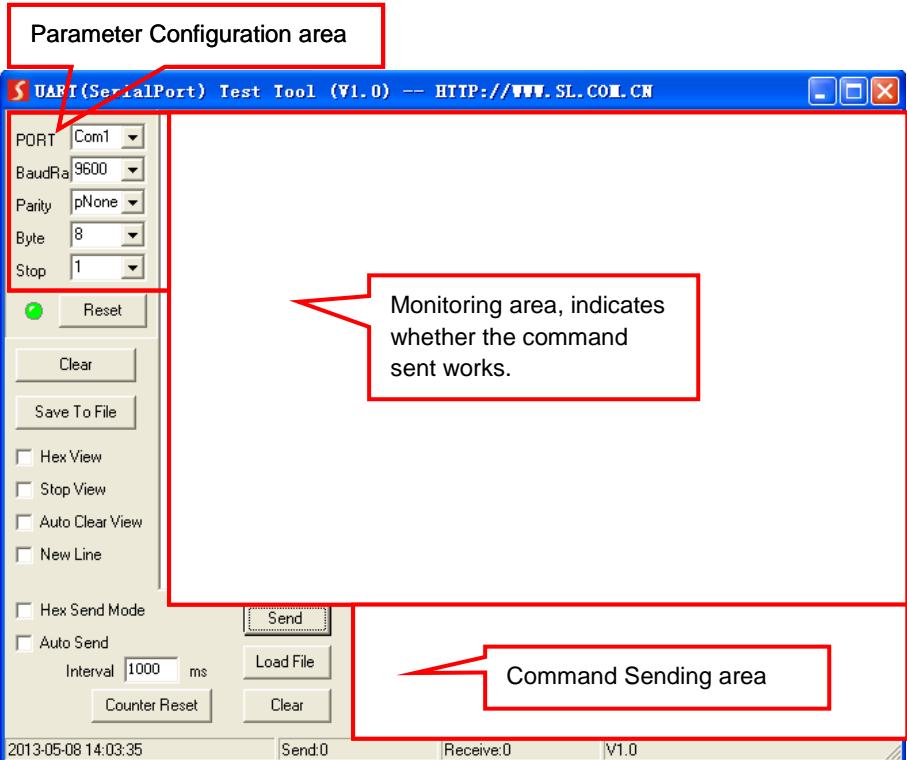

Please set the parameters of COM number, baud rate, data bit, stop bit and the parity bit correctly, only then will you be able to send command in Command Sending Area.

4.3.6 RS232 Communication Commands

Note:

- 1) Please disconnect all the twisted pairs before sending command EDIDUpgrade[X].
- 2) In above commands, “[” and “]” are symbols for easy reading and do not need to be typed in actual operation.
- 3) Please remember to end the commands with the ending symbols “.” and “;”.
- 4) Type the command carefully, it is case-sensitive.

Baud rate: 9600 Data bit: 8 Stop bit: 1 Parity bit: none

Command	Function	Feedback Example
System Commands		
/*Type;	Inquire the models information.	MUH44TPR2-N
/%Lock;	Lock the front panel buttons on the Matrix.	System Locked!
/%Unlock;	Unlock the front panel buttons on the Matrix.	System Unlock!
/^Version;	Inquire the version of firmware	VX.X.X
Demo.	Switch to the “demo” mode, convert input and output in turn like 1B1, 1B2, ...4B3, 4B4, 1B1... and so on .The switching interval is 2 seconds.	Demo Mode AV:01->01 IR:01->01 AV:01->02 IR:01->02 AV:04->04 IR:04->04
Undo.	To cancel the previous operation.	Undo Ok! Out 01 02 03 04 In 01 01 01 01
Operation Commands		
[x]All.	Transfer signals from the input channel [x] to all output channels	X To All. (X=01~04)
All#.	Transfer all input signals to the corresponding output channels respectively like 1->1, 2->2...	All Through.
All\$.	Switch off all the output channels.	All Closed.
[x]#.	Transfer signals from the input channel [x] to the output channel [x].	X Through. (X=01~04)
[x]\$.	Switch off the output channel [x].	X Closed. (X=01~04)
[x]@.	Switch on the output channel [x].	X Open. (X=01~04)
All@.	Switch on all output channels.	All Open.
[x1]V[x2].	Transfer the AV signal from the input channel [x1] to one or several output channels ([x2], separate output channels with comma).	AV: X1-> X2 (X1/X2=01~04)

Command	Function	Feedback Example
[x1]B[x2].	Transfer the AV and IR signal from input channel [x1] to one or several output channels ([x2], separate output channels with comma).	AV: X1-> X2 (X1/X2=01~04)
[x1] R[x2].	Transfer the IR signal from output [x1] to input [x2].	IR: X1-> X2(X1、X2=01~04)
Status[x].	Check the I/O connection status of output [x]	AV: Y-> X (X=01~04, Y=01~04)
Status.	Inquire the input channel to the output channels one by one.	AV: 01->01 AV: 04->04 IR: 01->01 IR: 04->04
Save[Y].	Save the present operation to the preset command [Y], ranges from 0 to 9.	Save To FY (Y=0-9)
Recall[Y].	Recall the preset command [Y].	Recall From FY (Y=0-9)
Clear[Y].	Clear the preset command [Y].	Clear FY (Y=0-9)
PWON.	Work in normal mode.	PWON
PWOFF.	Enter into standby mode and cut off the power supply to HDBaseT receivers.	PWOFF
STANDBY.	Enter into standby mode. (Do not cut off the power supply to HDBaseT receivers, press other buttons or send other commands to start.)	STANDBY
/%[Y]/[X]:[Z].	HDCP management command. [Y] is for input (value: I) or output (value: O); [X] is the number of the port, if the value of X is ALL, it means all ports; [Z] is for HDCP compliant status, the value may be 1 (HDCP compliant) or 0 (not HDCP compliant).	/%[Y]/[X]:[Z].
DigitAudioON[x].	Enable HDMI audio output of port x. ● X=1, 2, 3, 4, enable this port. ● X=5, enable all the 4 ports.	DigitAudio ON with [x]
DigitAudioOFF[x].	Disable HDMI audio output of port x. ● X=1, 2, 3, 4, disable this port.	DigitAudio OFF with [x]

Command	Function	Feedback Example
	<ul style="list-style-type: none"> ● X=5, disable all the 4 ports. <p>Set communication between PC and HDBaseT receiver.</p> <p>① Y is for RS232 port (connect with RS232 port of HDBaseT receiver) Y= 1~5 or A~H, The value of Y is defined into the following meanings (in a given baud rate depended by the value of X):</p> <ul style="list-style-type: none"> a. Y = 1~4, send this command to the corresponding HDBaseT receiver to control far-end device. b. Y = 5, send this command to all HDBaseT receivers to control all far-end devices. c. Y = A, B, C, or D d. Y = E, F, G, or H <p>For items c or d, send this command, it will be saved to the matrix switcher but taken without action to corresponding HDBaseT receiver. And its command function will be effective almost at the same time when you send the command PWON (for item c) or PWOFF (for item d).</p> <p>Note: A & E are for port 1. B & F are for port 2. C & G are for port 3. D & H are for port 4.</p> <p>② X is for baud rate, its value ranges from 1 to 7 (1--2400, 2--4800, 3--9600, 4--19200, 5--38400, 6--57600, 7--115200)</p> <p>③ ***** is for data (max 48 Byte)</p>	<p>*****</p>
<p>EDIDH[x]B[y].</p>	<p>Input port [y] learns the EDID from output port [x]. If the EDID data is available and the audio part supports not only PCM mode, then force-set it to support PCM mode only. If</p>	<p>EDIDH[x]B[y]</p>

Command	Function	Feedback Example
	the EDID data is not available, then set it as initialized EDID data.	
EDIDPCM[x].	Set the audio part of input port [x] to PCM format in EDID database.	EDIDPCM[x]
EDIDG[x].	Get EDID data from output [x] and display the output port number.	Hexadecimal EDID data and carriage return character
EDIDMInit.	Restore the factory default EDID data of every input.	EDIDMInit.
EDIDM[X]B[Y].	Manually EDID switching. Enable input[Y] to learn the EDID data of output[X]. If the EDID data is not available, then set it as initialized EDID data.	EDIDM[X]B[Y]
EDIDUpgrade [x].	Upgrade EDID data via the RS232 port. [x] is the input port, when the value of X is 9, it means to upgrade all input ports. When the switcher receives the command, it will show a message to prompt you to send EDID file (.bin file). Operations will be canceled after 10 seconds. Please cut off all connections of HDBaseT ports.	Please send the EDID file
EDID/[x]/[y].	Set the EDID data of input port [x] to built-in EDID No.[y]. [y]=1~5, correspond to the 5 embedded EDID data separately	EDID/[x]/[y]
UpgradeIntED ID[x].	Upgrade one of the 5 embedded EDID data, x is the serial number for EDID data: 1. 1080P 2D 2CH 2. 1080P 3D 2CH 3. 1080P 2D Multichannel 4. 1080P 3D Multichannel 5. 3840x2160 2D (30Hz) When the switcher gets the command, it will show a message to send EDID file (.bin file). Operations will be invalid after 10 seconds.	Please send the EDID file
GetIntEDID[x].	Return the embedded EDID data ranked	

Command	Function	Feedback Example
	x, [x]=1~5	
GetInPortEDID[X].	Return the EDID data of input [x], [x]=1~4	
%0801.	Auto HDCP management, activate carrier native mode	%0801
%0900.	Switch to carrier native mode.	Carrier native
%0901.	Switch to force carrier mode.	Force carrier
%0911.	Reset to factory default.	Factory Default
%9951.	Check the command sent by port 1 when PWON.	Port 1:data when PWON
%9952.	Check the command sent by port 2 when PWON.	Port 2:data when PWON
%9953.	Check the command sent by port 3 when PWON.	Port 3:data when PWON
%9954.	Check the command sent by port 4 when PWON.	Port 4:data when PWON
%9955.	Check the command sent by port 1 when PWOFF.	Port 1:data when PWOFF
%9956.	Check the command sent by port 2 when PWOFF.	Port 2:data when PWOFF
%9957.	Check the command sent by port 3 when PWOFF.	Port 3:data when PWOFF
%9958.	Check the command sent by port 4 when PWOFF.	Port 4:data when PWOFF
%9961.	Check the system locking status.	System Locked/Unlock!
%9962.	Check the power status	STANDBY/PWOFF/PWON
%9963.	Check the working mode of infrared carrier.	Carrier native/ Force carrier
%9964.	Check the IP address.	IP:192.168.0.178 (default)
%9971.	Check the connection status of the inputs.	In 01 02 03 04 Connect Y Y Y Y
%9972.	Check the connection status of the outputs.	Out 01 02 03 04 Connect Y Y Y Y
%9973.	Check the HDCP status of the inputs.	In 1 2 3 4 HDCP N N N N

Command	Function	Feedback Example
%9974.	Check the HDCP status of the outputs.	Out 1 2 3 4 HDCP N N N N
%9975.	Check the I/O connection status.	Out 01 02 03 04 In 04 04 04 04
%9976.	Check the output resolution.	Out 1 1920x1080 Out 2 1920x1080 Out 3 1920x1080 Out 4 1920x1080
%9977.	Check the status of digital audio of output channels.	Out 1 2 3 4 Audio Y Y Y Y
%9978.	Check the HDCP compliant status of the inputs.	In 01 02 03 04 HDCPEN Y Y Y Y

4.4 TCP/IP Control

MUH44TPR2-N boasts option TCP/IP port for IP control.

Default settings: IP: 192.168.0.178; Subnet Mast: 255.255.255.0; Gateway: 192.168.0.1; Serial Port: 4001.

IP& gateway can be changed as you need, Serial Port cannot be changed.

Connect the Ethernet port of control device and TCP/IP port of MUH44TPR2-N, and set same network segment for the 2 devices, users are able to control the device via web-based GUI or designed TCP/IP communication software.

4.4.1 Control Modes

MUH44TPR2-N can be controlled by PC without Ethernet access or PC(s) within a LAN.

● Controlled by PC

Connect a computer to the TCP/IP port of the MUH44TPR2-N, and set its network segment to the same as the MUH44TPR2-N's.

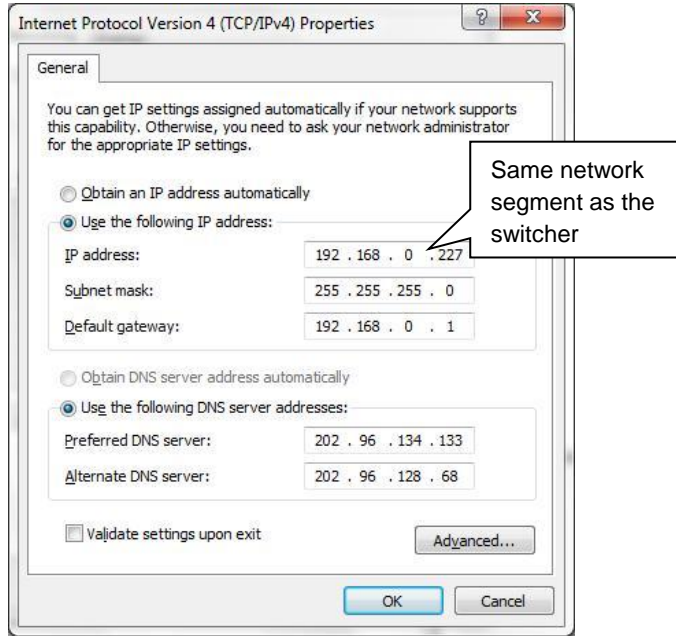

● **Controlled by PC(s) in LAN**

Connect MUH44TPR2-N, a router and several PCs to setup a LAN (as shown in the following figure). Set the network segment of MUH44TPR2-N to the same as the router's, then PCs within the LAN are able to control MUH44TPR2-N.

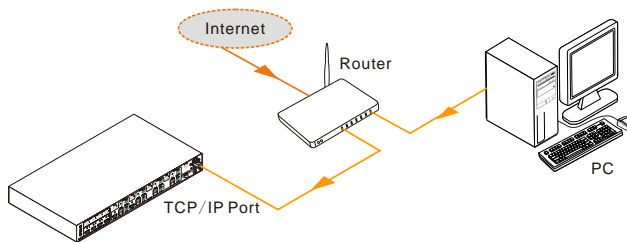

Follow these steps to connect the devices:

- Step1.** Connect the TCP/IP port of the MUH44TPR2-N to Ethernet port of PC with twisted pair.
- Step2.** Set the PC's network segment to the same as the MUH44TPR2-N's. Do please remember the PC's original network segment.
- Step3.** Set the MUH44TPR2-N's network segment to the same as the router.

Step4. Set the PC’s network segment to the original ones.

Step5. Connect the MUH44TPR2-N and PC(s) to the router. PC(s) within the LAN is able to control the MUH44TPR2-N asynchronously.

Then it’s able to control the device via GUI.

4.4.2 GUI for TCP/IP control

MUH44TPR2-N provides with built-in GUI for convenient TCP/IP control. GUI allows users to interact with MUH44TPR2-N through graphical icons and visual indicators.

Type 192.168.0.178 in your browser, it will enter the log-in interface shown as below:

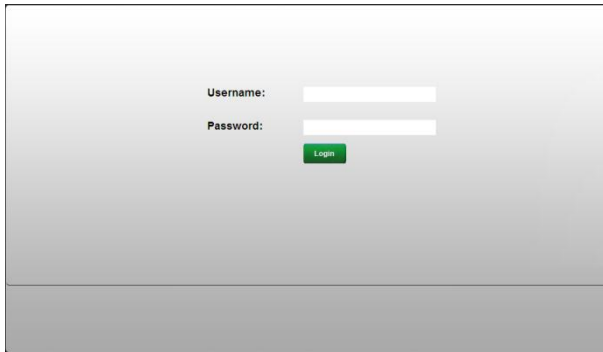

There are 2 selectable usernames – admin (default password: admin) and user (default password: user). Log in as admin can access more configuration interfaces than user. Enter username and the right password. Here is a brief introduction to the interfaces.

Main: Interface shown after logging in, provide intuitive I/O connection switching. See the screenshot below:

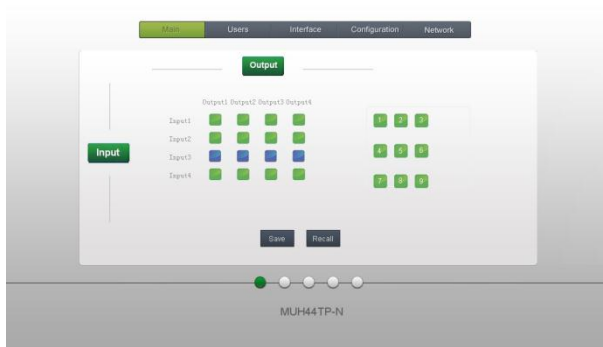

The button matrix displays every possible connection between every input and output,

users can carry on the connections by clicking corresponding button.

Buttons 1~9 at the right-bottom corner provides quick saving and recall for overall connection status.

Users: Display or modify credential settings, front panel lock, and GUI version.



If there is any modification, press Save to restore the settings, or press Cancel to withdraw.

Interface: Set title bar label, LCD readout, and button labels, press Save to save the settings



Configuration: Set HDCP Compliance status for every input, and manage EDID. See the screenshot below:



Network: Inquire and configure network settings including MAC address, IP address, subnet mask, and Gateway



Note: Log in as user access main interface only.

4.4.3 GUI Update

GUI for MUH44TPR2-N supports online update in <http://192.168.0.178:100>. Type the username and password (the same as the GUI log-in settings, modified password will be available only after rebooting) to log in the configuration interface. After that, click **Administration** at the source menu to get to **Upload Program** as shown below:

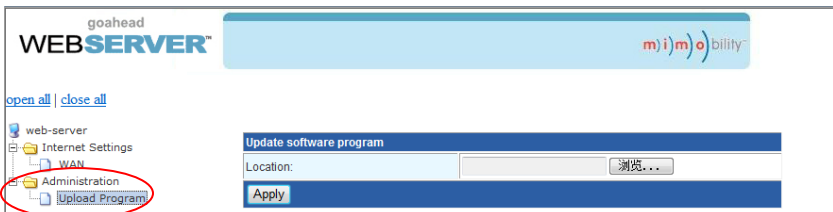

Select the desired update file and press Apply, it will start upgrading then.

4.5 Firmware Update via USB

MUH44TPR2-N boasts a USB port for online firmware upgrade on the front panel. Follow these steps to upgrade firmware:

Step1. Copy the upgrade software and the latest upgrade file (.bin) to PC.

Step2. Connect the USB ports of MUH44TPR2-N and the PC via USB cable.

Step3. Double-click the update software icon (see as below).



It will enter the upgrade interface shown as below:

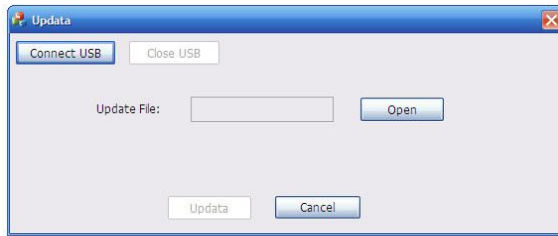

Step4. Click **Connect USB**.

Step5. Click **Open** to load the upgrade file, then click **Udata** to start firmware upgrading.

Note: To ensure available control, the COM number of the PC should be 1~9.

5. Specification

Video Input		Video Output	
Input	4 HDMI	Output	2 HDMI 4 HDBaseT
Input Connector	Female HDMI	Output Connector	Female HDMI Female RJ45(with LED indicators)
Input Level	T.M.D.S. 2.9V~3.3V	Output Level	T.M.D.S. 2.9V~3.3V
Input Impedance	100Ω (Differential)	Output Impedance	100Ω (Differential)
Video General			
Gain	0 dB	Bandwidth	10.2Gbit/s
Video Signal	HDMI (or DVI-D)	Resolution Range	Up to 4Kx2K@60Hz
Transmission Distance	1080P@60Hz ≤70m 4Kx2K@30Hz ≤40m	Switching Speed	200ns (Max.)
EDID Management	In-built EDID data and manual EDID management		
HDCP	Supports HDCP 2.2 auto and manual HDCP management.		
Audio General			
Output Signal	Stereo audio Digital audio	Output Connector	4 3-pin pluggable terminal blocks 4 Coax (RCA)
Stereo Output	Earphone output: distortion 0.1% 32Ω/70mW@1KHz, 0.1% 16Ω/105mW @1KHz, support PCM		
Coax Output	Supports PCM, Dolby Digital, DTS, DTS-HD		
Frequency Response	20Hz~20KHz		
Control Parts			
Control Ports	4 IR OUT (green) 4 IR IN (black) 1 IR EYE (black) 1 TCP/IP (female RJ45) 1 RS232 (9 pin female D) 4 RS232 (3-pin pluggable terminal blocks)		
Panel Control	Front panel buttons	RS232 Control	9-pin female RS232 connector
IR	Built-in IR sensor Extended IR receiver	TCP/IP Control	Web-based GUI

General			
Power Supply	DC 24V 2.71A	Power Consumption	48W (Max)
Temperature	-10 ~ +40°C	Reference Humidity	10% ~ 90%
Dimension (W*H*D)	437 x 44 x 235 mm (1U high, full rack wide)	Weight	2.0Kg

6 Panel Drawing

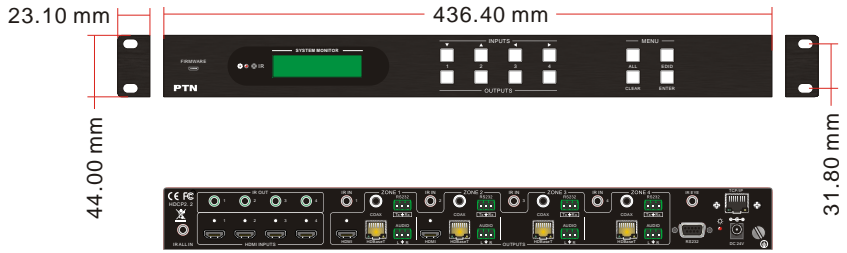

6. Troubleshooting & Maintenance

Problems	Causes	Solutions
Color losing or no video signal output	The connecting cables may not be connected correctly or it may be broken.	Check whether the cables are connected correctly and in working condition.
	Fail or loose connection	Make sure the connection is good
No output image when switching	No signal at the input / output end	Check with oscilloscope or multimeter if there is any signal at the input/ output end.
	Fail or loose connection	Make sure the connection is good
	Input source is with HDCP while the HDCP compliance is switched off.	Send command <code>/%[Y]/[X]:1.</code> or change HDCP compliance status in GUI.
	The display doesn't support the input resolution.	Switch for another input source or enable the display to learn the EDID data of the input.
Cannot control the device via front panel buttons	Front panel buttons are locked.	Send command <code>/%Unlock;</code> or select unlock in GUI interface to unlock
Cannot control the device via IR remote	The battery has run off.	Change for new battery.
	The IR remote is broken.	Send it to authorized dealer for repairing.
	Beyond the effective range of the IR signal or not pointing at the IR receiver	Adjust the distance and angle and point right at the IR receiver.
	The IR receiver connected to IR IN/ IR ALL IN port is not with carrier	Change for an IR receiver with carrier.
Power Indicator remains off when powered on	Fail or loose power connection	Check whether the cables are connected correctly

EDID management does not work normally	The HDMI cable is broken at the output end.	Change for another HDMI cable which is in good working condition.
There is a blank screen on the display when switching	The display does not support the resolution of the video source.	Switch again.
		Manage the EDID data manually to make the resolution of the video source automatically compliant with the output resolution.
Cannot control the device by control device (e.g. a PC) through RS232 port	Wrong connection	Check to ensure the connection between the control device and the unit
	Wrong RS232 communication parameters	Type in correct RS232 communication parameters: Baud rate:9600; Data bit: 8; Stop bit: 1; Parity bit: none
	Broken RS232 port	Send it to authorized dealer for checking.
Static becomes stronger when connecting the video connectors	Bad grounding	Check the grounding and make sure it is connected well.
Cannot control the device by RS232 / IR remote / front panel buttons	The device has already been broken.	Send it to authorized dealer for repairing.

If your problem persists after following the above troubleshooting steps, seek further help from authorized dealer or our technical support.

7. After-sales Service

If there appear some problems when running the device, please check and deal with the problems reference to this user manual.

1) Product Limited Warranty: PTN warrants that its products will be free from defects in materials and workmanship for **three years**, which starts from the first day the product leaves warehouse (check the SN mark on the product). Proof of purchase in the form of a bill of sale or receipted invoice must be presented to obtain warranty service.

2) What the warranty does not cover:

- Warranty expiration.
- Factory applied serial number has been altered or removed from the product.
- Damage, deterioration or malfunction caused by:
 - Normal wear and tear
 - Use of supplies or parts not meeting our specifications
 - No certificate or invoice as the proof of warranty.
 - The product model showed on the warranty card does not match with the model of the product for repairing or had been altered.
 - Damage caused by force majeure.
 - Servicing not authorized by PTN
 - Other causes which does not relate to a product defect
- Delivery, installation or labor charges for installation or setup of the product

3) Technical Support: Email to our after-sales department or make a call, please inform us the following information about your cases.

- Product version and name.
- Detailed failure situations.
- The formation of the cases.

Remarks: For any questions or problems, please try to get help from your local distributor, or email PTN at: support@PTN-electronics.com



www.av-box.ru

PTN Electronics Limited

Tel:8804333-18-83

Email:i@av-box.ru

Website:http://av-box.ru/

