

User Manual

FMX16

Single Plug-in Card Matrix Switcher



Preface

Read this user manual carefully before using the product. Pictures shown in this manual is for reference only. Different models and specifications are subject to real product.

This manual is only for operation instruction only. The functions described in this version are updated till August 14, 2017. In the constant effort to improve our product, we reserve the right to make functions or parameters changes without notice or obligation. Please refer to the dealers for the latest details.

Trademarks

Product model, AV-BOX and its logo are trademarks of AV-BOX. Any other trademarks mentioned in this manual are acknowledged as the properties of the trademark owner. No part of this publication may be copied or reproduced without the prior written consent of AV-BOX.

FCC Statement

This equipment generates, uses and can radiate radio frequency energy and, if not installed and used in accordance with the instructions, may cause harmful interference to radio communications. It has been tested and found to comply with the limits for a Class B digital device, pursuant to part 15 of the FCC Rules. These limits are designed to provide reasonable protection against harmful interference in a commercial installation.

Operation of this equipment in a residential area is likely to cause interference, in which case the user at their own expense will be required to take whatever measures may be necessary to correct the interference

Any changes or modifications not expressly approved by the manufacture would void the user's authority to operate the equipment.



SAFETY PRECAUTIONS

To insure the best from the product, please read all instructions carefully before using the device. Save this manual for further reference.

- Unpack the equipment carefully and save the original box and packing material for possible future shipment
- Follow basic safety precautions to reduce the risk of fire, electrical shock and injury to persons.
- Do not dismantle the housing or modify the module. It may result in electrical shock or burn.
- Using supplies or parts not meeting the products' specifications may cause damage, deterioration or malfunction.
- Refer all servicing to qualified service personnel.
- To prevent fire or shock hazard, do not expose the unit to rain, moisture or install this product near water.
- Do not put any heavy items on the extension cable in case of extrusion.
- Do not remove the housing of the device as opening or removing housing may expose you to dangerous voltage or other hazards.
- Install the device in a place with fine ventilation to avoid damage caused by overheat.
- Keep the module away from liquids.
- Spillage into the housing may result in fire, electrical shock, or equipment damage. If an object or liquid falls or spills on to the housing, unplug the module immediately.
- Do not twist or pull by force ends of the optical cable. It can cause malfunction.
- Do not use liquid or aerosol cleaners to clean this unit. Always unplug the power to the device before cleaning.
- Unplug the power cord when left unused for a long period of time.
- Information on disposal for scrapped devices: do not burn or mix with general household waste, please treat them as normal electrical wastes.

Contents

1. Introduction	1
1.1 Introduction to FMX16	1
1.2 Features	1
1.3 Package List	1
2. Panel Description	2
2.1 Front Panel	2
2.2 Rear Panel	4
2.3 Signal Cards	5
2.3.1 FMX-IUH& FMX-OUH	5
2.3.2 FMX-IBT& FMX-OBT	6
2.3.3 FMX-IUV	7
2.3.4 FMX-OAU	8
3. System Connection	9
3.1 Usage Precautions	9
3.2 System Diagram	9
3.3 Connection Procedures	10
3.4 Application	10
4. Front Panel Control	11
4.1 Switching I/O connection	11
4.2 EDID Learning	11
4.3 Inquiry	12
4.4 Clear operation	12
5. IR Control	13
6. RS232 Control	14
6.1 RS232 Control Software	14
6.2 RS232 Communication Commands	16
7. TCP/IP Control	25
7.1 Control Modes	25
7.2 Control via TCP/IP communication software	26
7.3 Control via web-based GUI	28

Single Plug-in Card Matrix Switcher

7.3.1 Switch Control	30
7.3.1.1. Scene Switch.....	30
7.3.1.2. I/O Switch	30
7.3.2 System Setting	31
7.3.2.1. Configuration	31
7.3.2.2. Status	34
7.3.2.3. EDID.....	36
7.3.2.4. Password.....	36
7.4 Port Management	37
8. Firmware Upgrade	38
9. Specification	39
9.1 Main Unit	39
9.2 Signal Cards	39
9.2.1 FMX-IUH& FMX-OUH	39
9.2.2 FMX-IBT& FMX-OBT.....	40
9.2.3 FMX-IUV	40
9.2.4 FMX-OAU	41
10. Panel Drawing	42
11. Troubleshooting & Maintenance	43
12. Customer Service	44

1. Introduction

1.1 Introduction to FMX16

FMX16 is a high-performance seamlessly AV modular matrix switcher providing 12 flexible PCIE slots for single HDMI/HDBaseT/VGA input/ output cards and 4 fixed slots for output signal cards.

With its advanced modularization design, Freedom combination of single HDBaseT/HDMI/VGA input/output card can make up different kinds of matrix. All the cards support plug-and-play. It supports different video signals with seamless cross switching. Every video or audio signal is transmitted and switched independently to decrease signal attenuation. The switcher can handle all the audiovisual management, including the switching, driving, scaling etc.

1.2 Features

- 12 card slots for flexible input/ output combination, and 4 slots for output signal cards.
- Comprehensive signal card compatibility: HDMI/HDBaseT/VGA.
- Automatically recognize input/ output signal card.
- Powerful EDID management.
- UPnP enables quick-connection to GUI.
- HDCP Compliant.
- Seamless AV distribution through different AV signal.
- Controllable via front panel buttons, IR, RS232 & TCP/IP.
- Adjustable output resolution.
- Online firmware upgrade via USB port.

1.3 Package List

- 1 x FMX16
- 1 x IR Receiver
- 2 x Mounting Ears
- 1 x IR Remote
- 4 x Plastic Cushions
- 1 x RS232 Cable
- 1 x Power Cord
- 1 x User Manual



Signal cards are sold and packed separately, all the items listed above are for the Matrix Switcher solely. Confirm all the accessories are included, if not, please contact with the dealers.

2. Panel Description

2.1 Front Panel

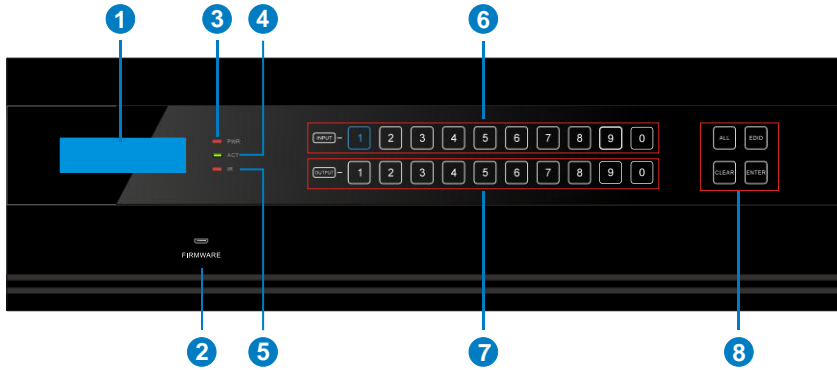

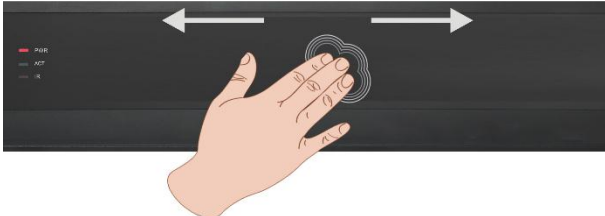
No.	Name	Description
	Description for Touch Screen	<ul style="list-style-type: none"> Touch any button to awake touch screen and white backlight will appear. If without any operations within 8 seconds, touch screen will enter sleep mode and the white backlight will goes out. <p>Note: Due to the buttons may not be able to touch successfully; the touch screen will not be awakened. In this case, please refer to the shown below to slide your finger left and right.</p>  <ul style="list-style-type: none"> When the touch screen is awaking, press any button, the white backlight of this buttons will turn into blue. Press the button of IR remote, the corresponding button will appear blue backlight.
①	LCD screen	Display real-time operation status.
②	FIRMWARE	Micro USB port, used for firmware update.
③	PWR	Power indicator: <ul style="list-style-type: none"> OFF: No power.

Single Plug-in Card Matrix Switcher

		<ul style="list-style-type: none"> ▪ RED: Normal work. ▪ Green: Standby.
④	ACT	RS232 Link indicator: OFF: No RS232 serial signal. Blinking Green: Transmit RS232 serial signal.
⑤	IR	IR indicator: <ul style="list-style-type: none"> ▪ OFF: No IR signal. ▪ Blinking red: when the built-in IR sensor receive IR signal.
⑥	INPUTS	Back-lit buttons for input selection, ranges from 0~9, 12 selectable channels in total.
⑦	OUTPUTS	Back-lit buttons for output selection, ranges from 0 ~ 9, 16 selectable channels in total.
⑧	MENU	ALL: Select all inputs/ outputs.
		EDID: EDID management button, enable input port to learn the EDID data from output devices.
		CLEAR: Withdraw an operation before it comes into effect/ exit inquiry mode.
		ENTER: confirm operation/ long-press (3s or more) to enter inquiry mode.



- Input/ output channels are recognized as double-digit, so press channel 1~9 as 01~09, besides, the interval should not exceed 8s.
- Operations will be automatically canceled 8s later unless pressing ENTER to confirm.

2.2 Rear Panel

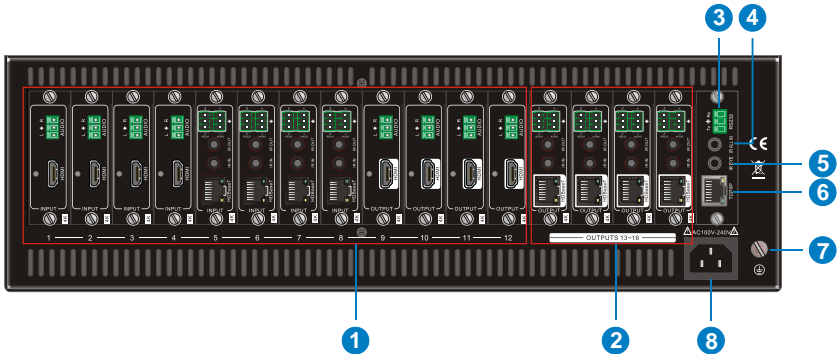

No.	Name	Description
①	1~12 Card Slots	Flexible card slots, 12 in total, insert input/ output signal cards here.
②	13~16 Card Slots	4 in total, insert output signal cards here.
③	RS232	Serial control port, connect with the RS232 port of control device to control the Matrix Switcher or the 3 rd party device connected to FMX-IBT & FMX-OBT.
④	IR ALL IN	Input port for IR control signal, connect with IR receiver (5V, with carrier), and work with IR emitters connected to IR OUT of far-end HDBT receivers.
⑤	IR EYE	Connect with IR receiver (5V, with carrier) to control the switcher.
⑥	TCP/IP	TCP/IP control port, connect with control device (e.g. a PC).
⑦	Ground	Connect to grounding.
⑧	Power port	Connect with 100~240V AC outlet.

 Pictures shown in this manual are only for reference.

2.3 Signal Cards

The Matrix Switcher boasts 12 card slot for flexible input& output signal card combinations, and 4 card slots for output signal cards, HDMI, HDBT and VGA signal card can be selected, according to specific need. All the signal cards support seamless distribution and hot-plug.

The chart below shows all signal cards:

Input		Output	
Card	Ports	Card	Ports
FMX-IUH	4K HDMI& Analog Audio	FMX-OUH	4K HDMI& Analog Audio
FMX-IBT	4K HDBT& Analog Audio& RS232&IR	FMX-OBT	4K HDBT& Analog Audio& RS232&IR
FMX-IUV	VGA & Analog Audio	FMX-OAU	MIC/LINE IN, MIX OUT & PGM OUT

2.3.1 FMX-IUH& FMX-OUH

Single 4K seamless HDMI signal card (refer to 9.2.1 for detailed specification).

HDMI1.4& HDCP2.2 compliant, capable to transmit HDMI/ DVI-I/DVI-D signal;

Auto-detect input resolution;

Max resolution: 4Kx2K@60Hz 4:2:0;

The default output resolution is 4Kx2K@30Hz and it can be adjusted via commands or GUI, support 4Kx2K@60Hz, 1024x768@60Hz, 1920x1080p@60Hz, 1280x720@60Hz;

Support EDID Management (default EDID: 4Kx2K@30Hz) and DDC communication;

Input audio source selectable via command or GUI, including HDMI embedded audio (default), and external analog audio;

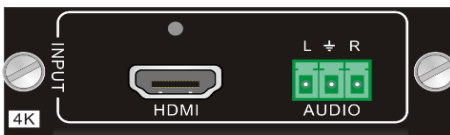

Figure 2- 1 FMX-IUH

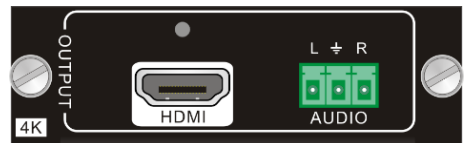
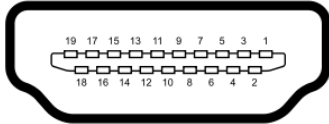

Figure 2- 2 FMX-OUH

Single Plug-in Card Matrix Switcher

Pin layout of the HDMI connector (female).



No.	Signal	No.	Signal
1	TMDS Data 2+	11	TMDS Clock Shield
2	TMDS Data 2 Shield	12	TMDS Clock-
3	TMDS Data 2-	13	CEC
4	TMDS Data 1+	14	N.C.
5	TMDS Data 1 Shield	15	SCL
6	TMDS Data 1-	16	SDA
7	TMDS Data 0+	17	DDC/CEC Ground
8	TMDS Data 0 Shield	18	+5V Power
9	TMDS Data 0-	19	Hot Plug Detect
10	TMDS Clock+		TMDS Clock Shield

2.3.2 FMX-IBT& FMX-OBT

4K seamless HDBT signal card (refer to 9.2.2 for detailed specification)

Max resolution: 4Kx2K@60Hz;

Adaptive HDCP input and support HDCP2.2, the output signal support HDCP1.4;

Work with HDBT transmitter/ receiver to attain long-distance transmission (up to 70m via qualified CAT6 cable for 1080P or 40m for 4K signal);

Real-time work status indicator: yellow LED blinks once powered on; green LED lights when the port is connected with HDBT devices;

HDBT port supports PoE;

Input audio source selectable via command or GUI, including HDMI embedded audio (default), and external analog audio;

The default output resolution is 4Kx2K@30Hz and it can be adjusted via commands or GUI, support 4Kx2K@60Hz, 1024x768@60Hz, 1920x1080p@60Hz, 1280x720@60Hz;

Support bi-directional RS232 control;

Support bi-directional IR control, compatible with 5V/12V IR receiver (default: 5V);

Support EDID Management (default EDID: 4Kx2K@30Hz) and DDC communication.

Single Plug-in Card Matrix Switcher

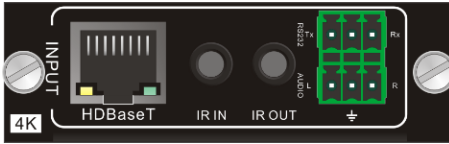

Figure 2- 3 FMX-IBT

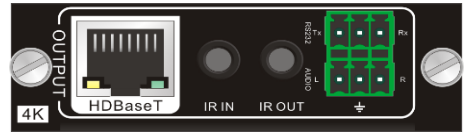
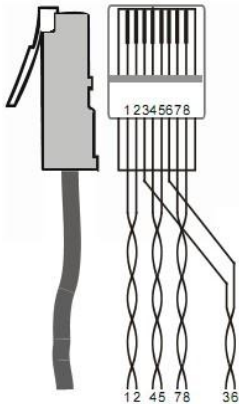

Figure 2- 4 FMX-OBT

Pin layout of the HDBT connector:



Pin	Color
1	orange white
2	orange
3	green white
4	blue
5	blue white
6	green
7	brown white
8	brown

Twist the pure-color cables with their half-color cables.

2.3.3 FMX-IUV

4K seamless VGA signal input card (refer to 9.2.3 for detailed specification);

Max VGA input resolutions: 1920×1200p@60Hz;

External analog audio input for VGA video signal;

Work with FMX-OUH/FMX-OBT output cards to switch video & audio input signal, and the video signal can be adjusted as 4K@30Hz 4:4:4.



Figure 2- 5 FMX-IUV

Note: When one PC used as input source, due to some models aren't compatible with this input signal card, the video image may not be displayed fully.

2.3.4 FMX-OAU

Audio signal output card (refer to 9.2.4 for detailed specification);

Support external MIC or LINE audio input;

Features MIX OUT port to output MIC/LINE & source audio simultaneously;

Features PGM OUT port to output MIC/LINE & source audio simultaneously, and then the mixed sound volume and channel can be controlled via web-based GUI;

Works with I-UH/ I-BT/I-UV to output the de-embedded audio.

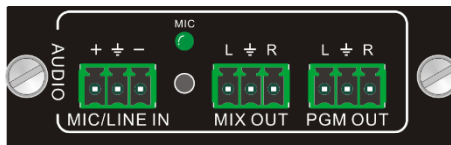

Figure 2- 6 FMX-OAU

3. System Connection

3.1 Usage Precautions

- System should be installed in a clean environment and has a prop temperature and humidity.
- All of the power switches, plugs, sockets and power cords should be insulated and safe.
- All devices should be connected before power on.

3.2 System Diagram

The following diagram illustrates typical input and output connections that can be utilized with the Matrix Switcher:

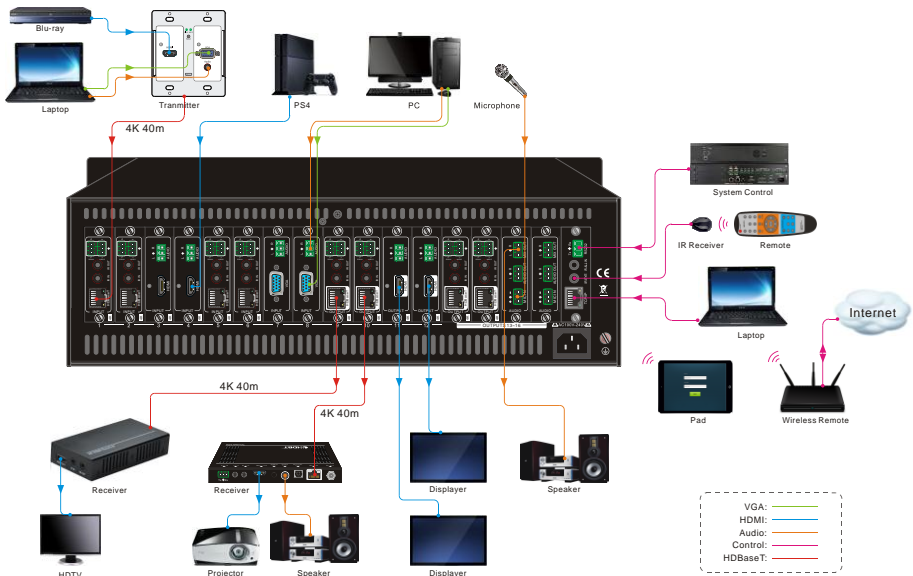

Note: System Diagram shown in this manual are for reference only, more specific schemes depend on real devices.

3.3 Connection Procedures

- Step1.** Insert necessary signal cards to the card slots.
- Step2.** Connect source device(s) (e.g. Blue-ray DVD) to corresponding input ports.
- Step3.** Connect displays to corresponding output ports.
- Step4.** Connect amplifier/ speaker to audio output ports.
- Step5.** Connect an IR Receiver to **IR EYE** to enable IR control.
- Step6.** Connect control device (e.g. a PC) to the RS232 port to enable serial control.
- Step7.** Connect control device (e.g. a PC) to the TCP/IP port to enable TCP/IP control.
- Step8.** Insert 100~240V AC outlet via the included power cord.

3.4 Application

Owing to its flexible card design, the Matrix Switcher is an all-in-one solution which is ideal for different projects such as public display, educational demo, professional presentation, advertising display or control center. The switcher can handle all the audiovisual management, including the switching, driving, scaling etc.

4. Front Panel Control

The Matrix Switcher provides with convenient front panel button control for I/O switch, EDID management, and system inquiry. Here we make a brief introduction to the operations.

4.1 Switching I/O connection

Input/ output channels are recognized in double-digit, press 01~09 for channel 1~9.

1) To convert one input to an output:

Operation: "INPUT"+"OUTPUT"+"ENTER"

Example: transfer input 1 to output 5:



2) To convert an input to several outputs:

Operation: "INPUT" + "OUTPUT" + "OUTPUT" +... + "ENTER"

Example: Switch input 2 to output 4, 5



3) To convert an input to all outputs:

Operation: "input" + "ALL" + "ENTER"

Example: Convert input 2 to all outputs



4.2 EDID Learning

The Matrix Switcher features EDID management to maintain compatibility between all devices.

➤ One input port learns the EDID data of one output port

Operation: "EDID"+"INPUT"+"OUTPUT"+"ENTER".

Example: Input 1 learns EDID data from output 10.

Single Plug-in Card Matrix Switcher

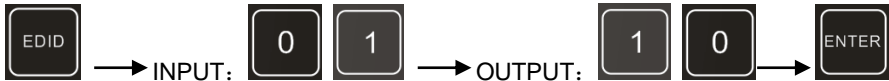

➤ All input ports learn EDID data from one output port

Operation: “EDID”+“ALL”+“OUTPUT”+“ENTER”

Example: All input ports learn EDID data from output 6



4.3 Inquiry

Press and hold the button “ENTER” for 3 seconds to enter system inquiry mode. The chart below shows information that can be inquired:

Function Items	Description	Example
Check customer serial	Interface shown after entering inquiry mode, customer serial can be changed via RS232 command.	K181201E01A15070 001 customer
Check output resolution	In inquiry mode, press output channel to check its resolution	Resolution: out02 1920×1080P
Correspondence between inputs and outputs	“OUTPUT” + “ENTER”	Matrix Switch AV: 06 ->08

4.4 Clear operation

Function: clear the previous operations before pressing **ENTER** to enforce it. Press **CLEAR** can only erase the operations not confirmed by pressing **ENTER**.



- Input/ output channels are recognized in double-digit, press 01~09 instead of 1~9.
- The input delay time between two numbers of every input& output channel must be less than 8 seconds; otherwise the operation will be cancelled.
- The input/output channels on the rear panel are counting from left to right no matter whether there is signal card.

5. IR Control

Connect an IR receiver to **IR EYE** on the rear panel, users can control the switcher with the included IR remote (shown as below):



- ① Standby: enter/ exit standby mode
- ② INPUTS: input selection buttons, channels 1~9 should be pressed as 01~09
- ③ Function Buttons: share the same operation with front panel buttons
- ④ ENTER:
 - confirm operation
 - long-press (3 seconds or more) to enter inquiry modeNote: navigation buttons are unavailable.
- ⑤ OUTPUTS: output selection buttons, channels 1~9 should be pressed as 01~09

6. RS232 Control

The Matrix Switcher provides with one RS232 port for serial port control. Connect the Matrix Switcher to the control device (e.g. a PC) with RS232 cable and set the correct parameters, the control device is capable to control the Matrix Switcher via designed software.

6.1 RS232 Control Software

Installation: Copy the control software file to the computer connected with the Matrix Switcher.

Uninstallation: Delete all the control software files in corresponding file path.

Basic Settings:

Firstly, connect the Matrix Switcher with an input device and an output device. Then, connect it with a computer which is installed with RS232 control software. Double-click the software icon to run this software.

Here we take the software **CommWatch.exe** as example. The icon is showed as below:



The interface of the control software is showed as below:

Single Plug-in Card Matrix Switcher

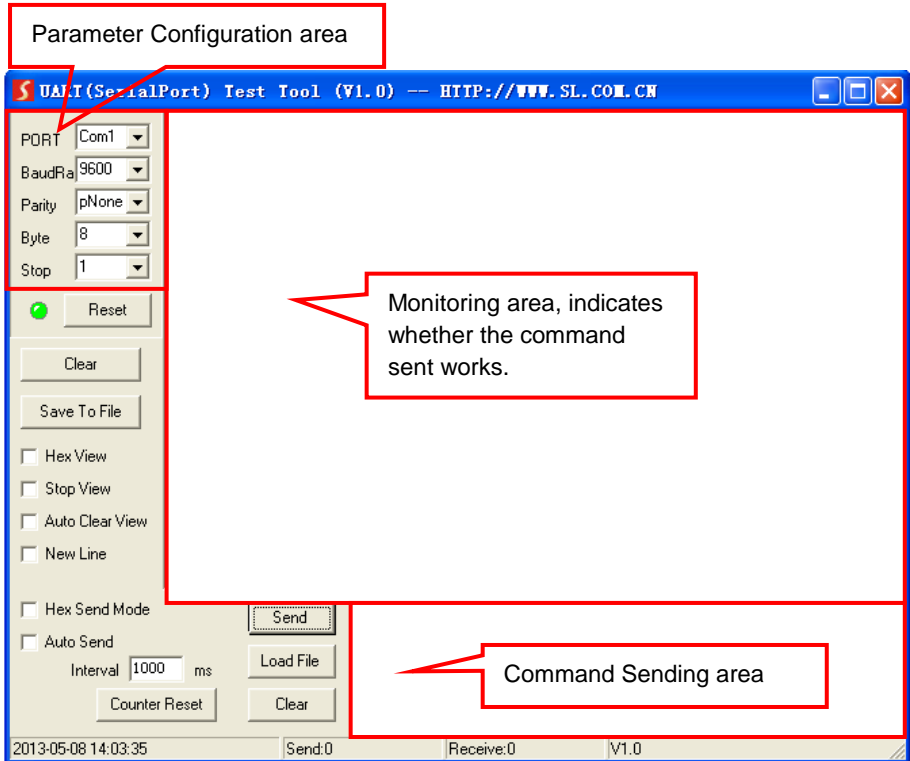

Please set the parameters of COM number, bound rate, data bit, stop bit and the parity bit correctly, only then will you be able to send command in Command Sending Area.

6.2 RS232 Communication Commands



- Case insensitive.
- In following commands, “[” and “]” are symbols for easy reading and do not need to be typed in actual operation.
- Type in the complete commands including ending symbol “.” or “;”.
- For input/ output channels 1~9 in the commands, type in 01~09 instead of 1~9.
- After sending command “%0911.” to restore factory default, wait for 10s or so before you reboot the device. Or the restoration may fail, and it will prompt “Default failed, please try again!” in the feedback.

Communication Protocol: Baud rate: 9600; Data bit: 8; Stop bit: 1; Parity bit: none.

Command	Description	Feedback
System Command		
/*Type;	Inquire the model	FMX16
/%Lock;	Lock the front panel buttons	System Locked!
/%Unlock;	Unlock the front panel buttons	System Unlock!
/^Version;	Inquire the firmware version	VX.X.X
/:MessageOff;	Turn off the feedback from the com port. It only shows “switcher OK”.	/:MessageOff;
/:MessageOn;	Turn on the feedback from the com port.	/:MessageOn;
Operation Command		
Undo.	Cancel the previous operation.	Undo Ok!
Demo.	Switch to the “demo” mode, 02->01, 2->2, 3->3 ... and so on.	Demo Mode AV: 02-> 01
[x]All.	Transfer signal from Input [x] to all outputs	02 To All.
All@.	Switch on all the outputs	All Open.
All\$.	Switch off all the outputs	All Closed.
[x]@.	Switch on output [x]	02 Open.
[x]\$.	Switch off output [x]	01 Closed.

Single Plug-in Card Matrix Switcher

[x1]V[x2],[x3],[x4]...	Transfer signal from input [x1] to output [x2],[x3],[x4]..., separate output channels with “,”	AV: 01->07 AV: 01->08 ...
Save[Y].	Save the present operation to the preset command [Y], [Y]=0~9	Save To F1
Recall[Y].	Recall the preset command [Y]	Recall From F1 AV: 02->04 AV: 02->06 ...
Clear[Y].	Clear the preset command [Y]	Clear F1
EDIDMInit.	Reset factory default EDID	EDIDMInit.
EDIDM[X]B[Y].	Manage EDID, enable input [Y] learn EDID data from output [X]	EDIDM07B03
PWON.	Work normally	PWON
PWOFF.	Enter standby mode	PWOFF
STANDBY.	Enter standby mode, can be awoken via front panel button operations	STANDBY
/+[Y]/[X]:*****.	<p>Set communication between PC and HDBaseT receiver.</p> <p>① Y is for RS232 port (connect with RS232 port of HDBaseT receiver)</p> <p>a. Y = 1 ~ 16, send this command to the corresponding HDBaseT receiver to control far-end device when the Matrix Switcher is working properly.</p> <p>b. Y = A ~ P, send this command to the corresponding HDBaseT receiver when the Matrix Switcher is PWON.</p> <p>c. Y = a ~ p, send this command to the corresponding HDBaseT receiver when the Matrix Switcher is PWOFF.</p> <p>② X is for baud rate, its value ranges from 1 to 7 (1=2400; 2=4800; 3=9600; 4=19200; 5=38400; 6=57600; 7=115200)</p> <p>③ ***** is for data (max 48 Byte).</p>	<p>601%</p> <p>Volume of MIC : 60 (***** and feedback from HDBT receiver)</p>

Single Plug-in Card Matrix Switcher

CustomerSerial:11 1111111111111111 11.	Set the customer serial number	customer serial is 111111111111111111
HDCPON.	Open HDCP for all output cards.	HDCP ON
HDCPOFF.	Close HDCP for all output cards.	HDCP OFF
%0911.	Reset factory default.	Factory Default
Inquiry Command		
Status[x].	Inquire the respective input for output [x].	AV:01-> 02
Status.	Inquire respective inputs for all outputs.	AV:01->02 AV:03->06
CheckInKatype.	Get the input signal card type *-- no available input signal card/ output card, 1--VGA, 2--DVI, 4--BT, 5--SDI, 6—HDMI.	Channel IN:*11*4**11*4*.
CheckOutKatype.	Get the output signal card type *-- no available output signal card/ input card, 1--VGA, 2--DVI, 4--BT, 6—HDMI.	Channel OUT: ***4*62**1**.
%9961.	Get current keylock status.	System Unlock!/ System Locked!
%9962.	Inquire current working status.	PWON/STANDBY /PWOFF
%9963.	Return all input& output connection status.	Port 01 02 03 04 Mode In In In In Port 05 06 07 08 Mode In Ou In In Port 09 10 11 12 Mode Ou Ou In Ou Port 13 14 15 16 Mode Ou Ou Ou Ou
%9964.	Inquire the IP.	IP: 192.168.0.178
%9973.	Return resolutions of all outputs.	Resolution Out02 1920x1080P 60 Resolution Out04 1920x1080P 60

Single Plug-in Card Matrix Switcher

%9974.	Get current HDCP Status of output port. "X" means input port or no signal cards. "Y" means the output signal traffic with HDCP; "N" means not.	Out 01 02 03 04 HDCP X X X X Out 05 06 07 08 HDCP X N X X Out 09 10 11 12 HDCP N N X N Out 13 14 15 16 HDCP N N N N
%9975.	Get current input& output card correspondence status.	Out 01 02 03 04 In 00 00 00 00 Out 05 06 07 08 In 00 01 00 00 Out 09 10 11 12 In 01 01 00 01 Out 13 14 15 16 In 01 01 01 01
%9976.	Get the output card type.	Channel 6 output mode is Digital Channel 9 output mode is Digital
%9978.	Inquire output resolution configuration mode (manual/ auto EDID).	Channel xx is auto/manual signal format
%9979.	Inquire the customer serial number.	customer serial is 111111111111111111
%9981.	Inquire input/output type of current inserted cards. Note: If there is no card inserted in a slot, it will show "Nc" instead of In/ Ou.	Port 01 02 03 04 Mode In In In In Port 05 06 07 08 Mode In Ou In In Port 09 10 11 12 Mode Ou Ou In Ou Port 13 14 15 16 Mode Ou Ou Ou Ou Channel status has changed
%8800.	Get the command sent to port 1 when PWON.	Port 1: 1A1. when PWON
%8801.	Get the command sent to port 2 when PWON.	Port 2: 1A1. when PWON

Single Plug-in Card Matrix Switcher

%8802.	Get the command sent to port 3 when PWON.	Port 3: 1A1. when PWON
%8803.	Get the command sent to port 4 when PWON.	Port 4: 1A1. when PWON
%8804.	Get the command sent to port 5 when PWON.	Port 5: 1A1. when PWON
%8805.	Get the command sent to port 6 when PWON.	Port 6: 1A1. when PWON
%8806.	Get the command sent to port 7 when PWON.	Port 7: 1A1. when PWON
%8807.	Get the command sent to port 8 when PWON.	Port 8: 1A1. when PWON
%8808.	Get the command sent to port 9 when PWON.	Port 9: 1A1. when PWON
%8809.	Get the command sent to port 10 when PWON.	Port 10: 1A1. when PWON
%8810.	Get the command sent to port 11 when PWON.	Port 11: 1A1. when PWON
%8811.	Get the command sent to port 12 when PWON.	Port 12: 1A1. when PWON
%8812.	Get the command sent to port 13 when PWON.	Port 13: NO Data when PWON
%8813.	Get the command sent to port 14 when PWON.	Port 14: NO Data when PWON
%8814.	Get the command sent to port 15 when PWON.	Port 15: NO Data when PWON
%8815.	Get the command sent to port 16 when PWON.	Port 16: NO Data when PWON
%8816.	Get the command sent to port 1 when PWOFF.	Port 1: 2A1. when PWOFF
%8817.	Get the command sent to port 2 when PWOFF.	Port 2: 2A1. when PWOFF
%8818.	Get the command sent to port 3 when PWOFF.	Port 3: 2A1. when PWOFF
%8819.	Get the command sent to port 4 when PWOFF.	Port 4: 2A1. when PWOFF
%8820.	Get the command sent to port 5 when PWOFF.	Port 5: 2A1. when PWOFF
%8821.	Get the command sent to port 6 when PWOFF.	Port 6: 2A1. when PWOFF

Single Plug-in Card Matrix Switcher

%8822.	Get the command sent to port 7 when PWOFF.	Port 7: 2A1. when PWOFF
%8823.	Get the command sent to port 8 when PWOFF.	Port 8: 2A1. when PWOFF
%8824.	Get the command sent to port 9 when PWOFF.	Port 9: 2A1. when PWOFF
%8825.	Get the command sent to port 10 when PWOFF.	Port 10: 2A1. when PWOFF
%8826.	Get the command sent to port 11 when PWOFF.	Port 11: 2A1. when PWOFF
%8827.	Get the command sent to port 12 when PWOFF.	Port 12: 2A1. when PWOFF
%8828.	Get the command sent to port 13 when PWOFF.	Port 13: NO Data when PWOFF
%8829.	Get the command sent to port 14 when PWOFF.	Port 14: NO Data when PWOFF
%8830.	Get the command sent to port 15 when PWOFF.	Port 15: NO Data when PWOFF
%8831.	Get the command sent to port 16 when PWOFF.	Port 16: NO Data when PWOFF
Commands for Signal Cards		
FMX-IUH		
USER/I/[x]:0706%;	Set the audio source of input [x] to HDMI embedded audio.	Channel 04 in audio command is:0706%
USER/I/[x]:0707%;	Set the audio source of input [x] to analog audio.	Channel 04 in audio command is:0707%
USER/I/[x]:0408%;	Restore the signal card to its factory default settings.	
FMX-OUH		
USER/O/[x]:0804%;	Set the resolution of output [x] to 720P 60Hz.	Resolution Out08 1280x720P
USER/O/[x]:0813%;	Set the resolution of output [x] to 1080P 60Hz.	Resolution Out08 1920x1080P
USER/O/[x]:0824%;	Set the resolution of output [x] to 1024x768 60Hz.	Resolution Out08 1024x768
USER/O/[x]:0840%;	Set the resolution of output [x] to 3840x2160 30Hz.	Resolution Out08 3840x2160 30Hz
USER/O/[x]:0841%;	Set the resolution of output [x] to 3840x2160 60Hz.	Resolution Out08 3840x2160 60Hz

Single Plug-in Card Matrix Switcher

USER/I/[x]:0408%;	Restore the signal card to its factory default settings.	
FMX-IBT		
USER/I/[x]:0706%;	Set the audio source of input [x] to HDMI embedded audio	Channel 04 in audio command is:0706%
USER/I/[x]:0707%;	Set the audio source of input [x] to analog audio	Channel 04 in audio command is:0707%
USER/I/[x]:0408%;	Restore the signal card to its factory default settings.	
USER/I/[x]:0409%;	RS232 pass-through control mode 1: Control far-end device from the RS232 port of this input card.	
USER/I/[x]:0410%;	RS232 pass-through control mode 2(factory default): Control far-end device from the RS232 port of this Matrix Switcher.	
FMX-OBT		
USER/O/[x]:0804%;	Set the resolution of output [x] to 720P 60Hz	Resolution Out08 1280x720P
USER/O/[x]:0813%;	Set the resolution of output [x] to 1080P 60Hz	Resolution Out08 1920x1080P
USER/O/[x]:0824%;	Set the resolution of output [x] to 1024x768 60Hz	Resolution Out08 1024x768
USER/O/[x]:0840%;	Set the resolution of output [x] to 3840x2160 30Hz	Resolution Out08 3840x2160 30Hz
USER/O/[x]:0841%;	Set the resolution of output [x] to 3840x2160 60Hz	Resolution Out08 3840x2160 60Hz
USER/O/[x]:0408%;	Restore the signal card to its factory default settings.	
USER/O/[x]:0409%;	RS232 pass-through control mode 1: Control far-end device from the RS232 port of this output card.	
USER/O/[x]:0410%;	RS232 pass-through control mode 2(factory default): Control far-end device from the RS232 port of this Matrix Switcher.	
FMX-OAU		
Setup commands		

Single Plug-in Card Matrix Switcher

PortXX/InputMic.	Switch the audio input channel of port xx to MIC.	Port XX Switch to mic.
PortXX/InputLine.	Switch the audio input channel of port xx to LINE.	Port XX Switch to line.
PortXX/SetMicVol:XX.	Set the MIC volume of port xx to xx.	Port XX Volume of MIC: xx. (xx can be 0-60)
PortXX/SetSourceVolume:XX.	Set the source volume of port xx to xx.	Port XX Volume of SOURCE : xx. (xx can be 0-60)
PortXX/MicVolume+.	Increase the MIC volume of port xx.	Port XX Volume of MIC : xx. (xx can be 0-60)
PortXX/MicVolume-.	Decrease the MIC volume of port xx.	Port XX Volume of MIC : xx. (xx can be 0-60)
PortXX/SourceVolume+.	Increase the source volume of port xx.	Port XX Volume of SOURCE : xx.
PortXX/SourceVolume-.	Decrease the source volume of port xx.	Port XX Volume of SOURCE : xx.
PortXX/SetStereo.	Switch the output audio mode of port xx to stereo.	Port XX Output is stereo mode.
PortXX/SetMono.	Switch the output audio mode of port xx to mono.	Port XX Output is mono mode.
PortXX/MicMute.	Mute the MIC audio of port xx.	Port XX Mic Mute.
PortXX/MicUnmute.	Unmute the MIC audio of port xx.	Port XX Mic Unmute.
PortXX/SourceMute.	Mute the source audio of port xx.	Port XX Source Mute.
PortXX/SourceUnmute.	Unmute the source audio of port xx.	Port XX Source Unmute.
Inquire commands		
%9921.	Inquire the input audio channel.	Port XX Switch to mic. Port XX Switch to line.
%9922.	Inquire the output audio mode.	Port XX Output is stereo mode. Port XX Output is mono mode.
%9923.	Inquire the mute status of MIC audio.	Port XX Mic Mute. Port XX Mic Unmute.
%9925.	Inquire the mute status of source audio.	Port XX Source Mute. Port XX Source Unmute.

Single Plug-in Card Matrix Switcher

%9926.	Inquire the volume of MIC audio.	Port XX Volume of MIC : xx.
%9928.	Inquire the volume of source audio.	Port XX Volume of SOURCE : xx.

7. TCP/IP Control

The Matrix Switcher boasts TCP/IP port for IP control.

Default settings: IP: 192.168.0.178; Subnet Mast: 255.255.255.0; Gateway: 192.168.0.1; Serial Port: 4001.

IP& gateway can be changed as you need, Serial Port cannot be changed.

Connect the Ethernet port of control device and TCP/IP port of the Matrix Switcher, and set same network segment for the 2 devices, users are able to control the device via web-based GUI or designed TCP/IP communication software.

7.1 Control Modes

The Matrix Switcher can be controlled by PC without Ethernet access or PC(s) within a LAN.

- **Controlled by PC without Ethernet access**

Connect a computer to the TCP/IP port, and set its network segment to the same as the Matrix Switcher's.

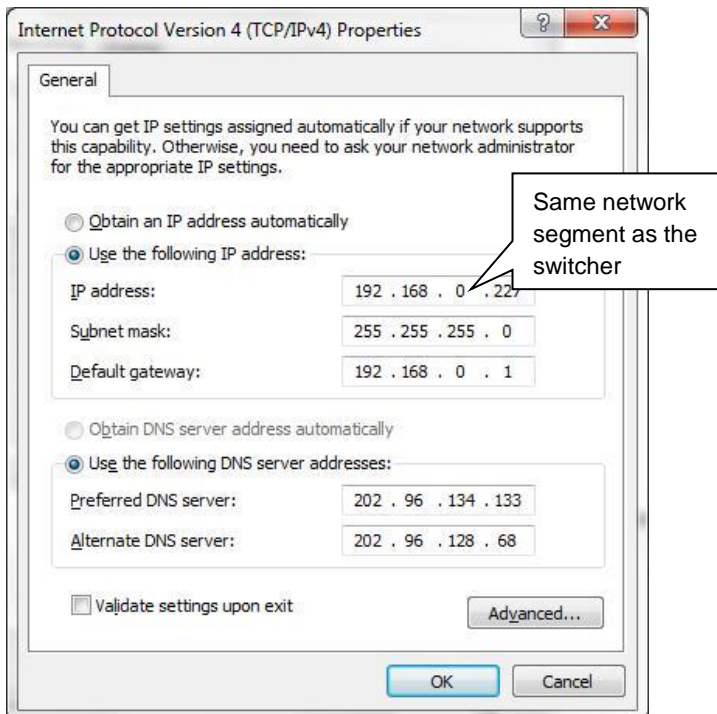

Single Plug-in Card Matrix Switcher

● Controlled by PC(s) in LAN

Connect the Matrix Switcher, a router and several PCs to setup a LAN (as shown in the following figure). Set the network segment of the Matrix Switcher to the same as the router's, then PCs within the LAN are able to control the Matrix Switcher.

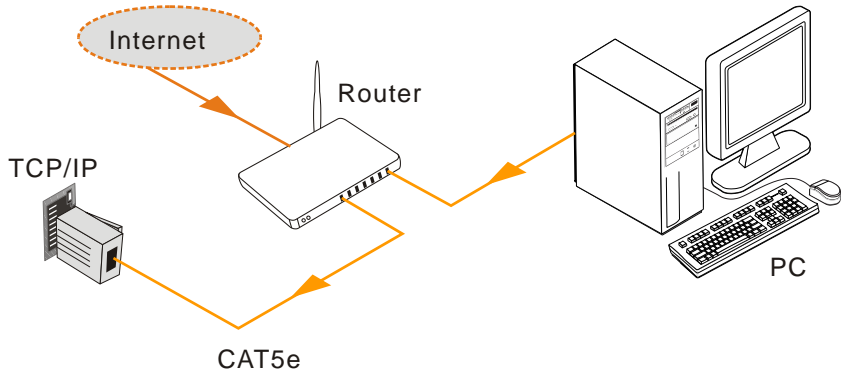

Follow these steps to connect the devices:

- Step1.** Connect the TCP/IP port of the Matrix Switcher to Ethernet port of PC with straight-thru CAT5e/6.
- Step2.** Set the PC's network segment to the same as the Matrix Switcher's.
- Step3.** Set the Matrix Switcher's network segment to the same as the router.
- Step4.** Set the PC's network segment to the original ones.
- Step5.** Connect the Matrix Switcher and PC(s) to the router. PC(s) within the LAN is able to control the Matrix Switcher asynchronously.

7.2 Control via TCP/IP communication software

(Exemplified by TCPUDP software)

- 1) Connect a computer and the Matrix Switcher to the same network. Open the TCPUDP software (or any other TCP/IP communication software) and create a connection, enter the IP address and port of the Matrix Switcher (default IP: 192.168.0.178, port:4001):

Single Plug-in Card Matrix Switcher

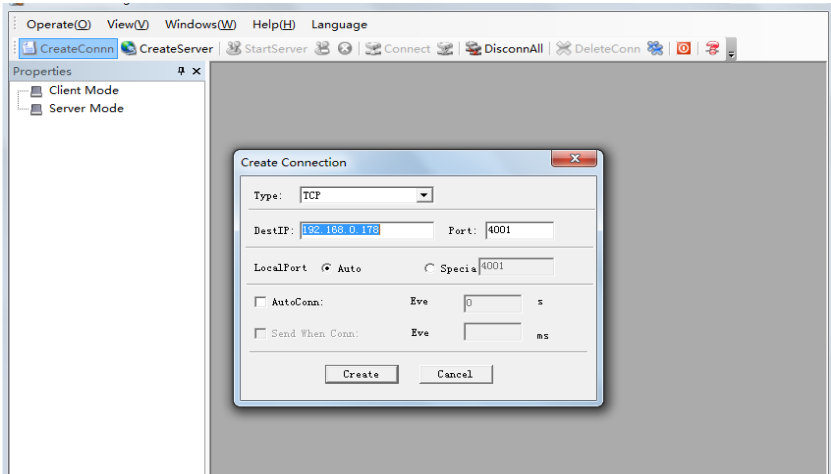

- 2) After connect successfully, we can enter commands to control the Matrix Switcher, as below:

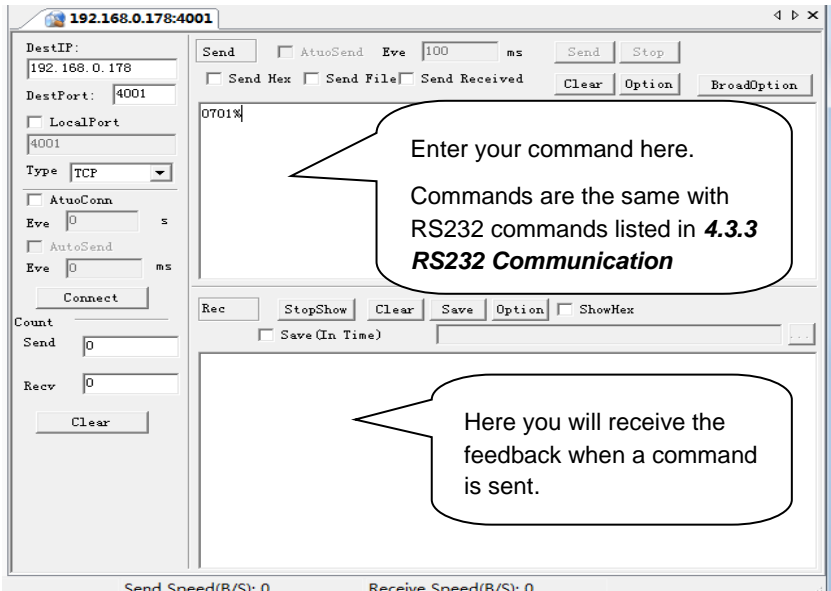

7.3 Control via web-based GUI

The Matrix Switcher provides with built-in GUI for convenient TCP/IP control. GUI allows users to interact with the Matrix Switcher through graphical icons and visual indicators.

Access GUI interface through any one of the following methods:

- Access through UPnP: Go to **My Network Place** in your PC, and click the icon named the Matrix Switcher.
- Access through web browser: type the IP of the device (default: 192.168.0.178, changeable) in the browser

 PCs running Windows XP system may occur issues in finding UPnP icon, follow these steps to switch on UPnP protocol:

- ① Add UPnP component: go to **“Control Panel”** -> double-click **“Add/ Delete Programs”** -> double-click “Add/ Delete windows component” -> tick “UPnP” -> click “Next” -> click “OK”
- ② Enable Windows Firewall: go to **“Control Panel”** -> double-click **“Windows Firewall”** -> click “Others” -> tick “UPnP framework”
- ③ Enable UPnP auto-starting: go to **“Control Panel”** -> double-click **“Administrative Tools”** -> double-click “Services” -> find and click **SSDP Discovery Serviv** and **Universal Plug and Play Device Host** -> click “OK”
UPnP will now automatically start when you turn on your computer.
- ④ Reboot the device.

The log-in interface is shown below:

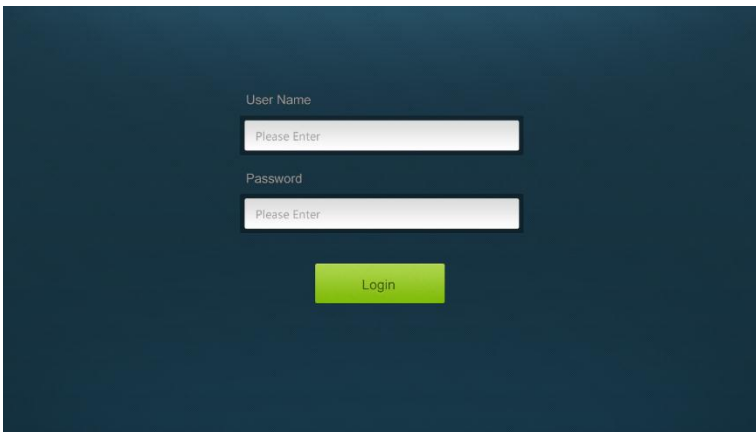

There are 2 selectable accounts to log in. Type the right name and password in relative column and click **Login** to enter configuration interfaces.



Single Plug-in Card Matrix Switcher

- **Name:** admin; **Password:** admin (default setting, changeable via GUI)
- **Name:** user; **Password:** user (default setting, changeable via GUI)

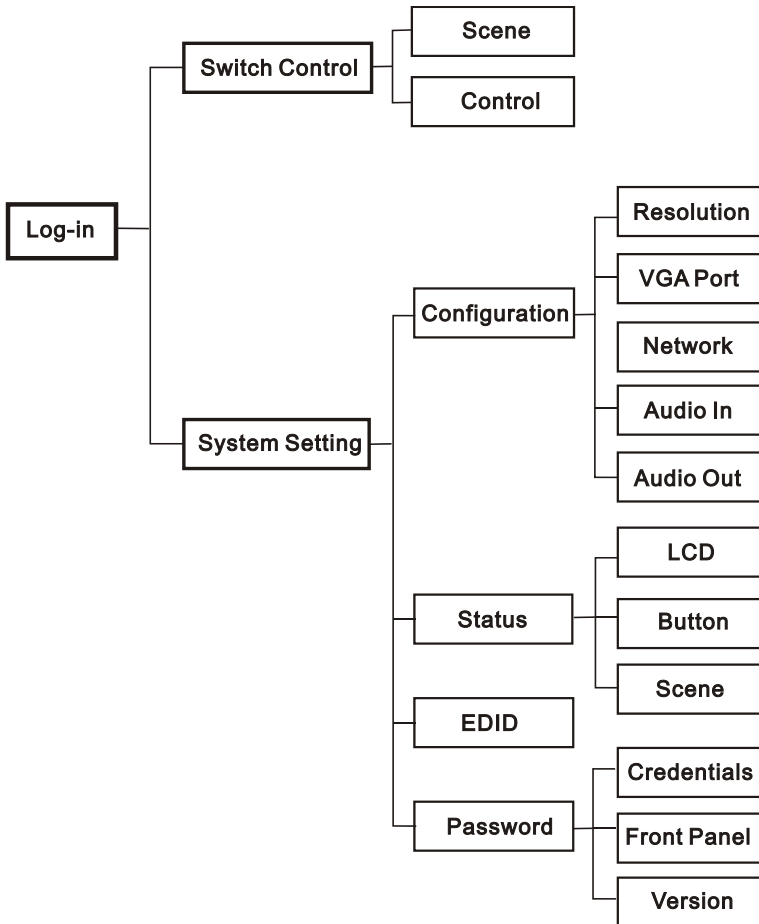
It will enter scene management interface (left) after log-in, which provides direct scene switch. The chart below illustrates the main structure of GUI interfaces:



The web-based GUI system can be divided into Switch Control and System Setting menu, but log in as user will only access Switch Control.

- Click  at the left-bottom corner to enter Switch Control menu.
- Click  at the left-bottom corner to enter System Setting menu.

7.3.1 Switch Control

This menu boasts 3 selectable interfaces in total, including scene switch interface and I/O switch interface.

7.3.1.1. Scene Switch

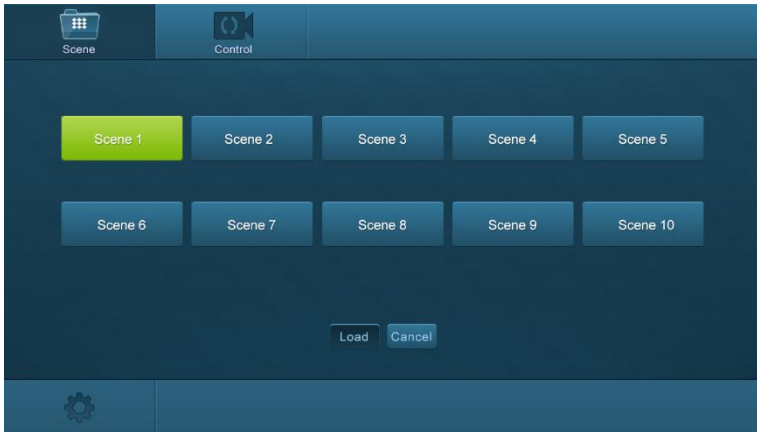

All ten scenes are shown in above interface. Select a scene and then click “**Load**” can invoke the selected scene. Click “**cancel**” to cancel the current operation.

7.3.1.2. I/O Switch



Single Plug-in Card Matrix Switcher

The button matrix displays every possible connection between every input and output; users can carry on the connections by clicking corresponding button. **For example:**

Step1: Select button1 at INPUT column

Step2: Select button 10 at OUTPUT column (If all OUTPUT ports in needed, you only need to click “All”.)

Step3: Choose a scene that you want to save.

Step4: Click “**Confirm**” to save the setting or Click “**Clear**” to clear set up.

7.3.2 System Setting

This menu boasts 4 submenu items in total, including configuration, status, EDID and password.

7.3.2.1. Configuration

6 submenu items in total, including Resolution, VGA Port, Network, Audio In, Audio Out and Audio port.

① Configure output resolution

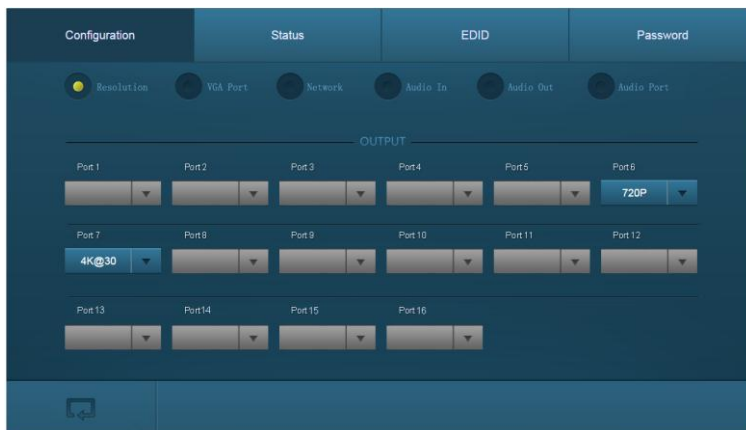

In this interface, you can set output resolution.

FMX-OUH& FMX-OBT: 4Kx2K@60Hz、4Kx2K@30Hz、1024x768@60Hz、1920x1080p@60Hz、1280x720@60Hz.

FMX-OAU: Unavailable.

② Configure VGA port

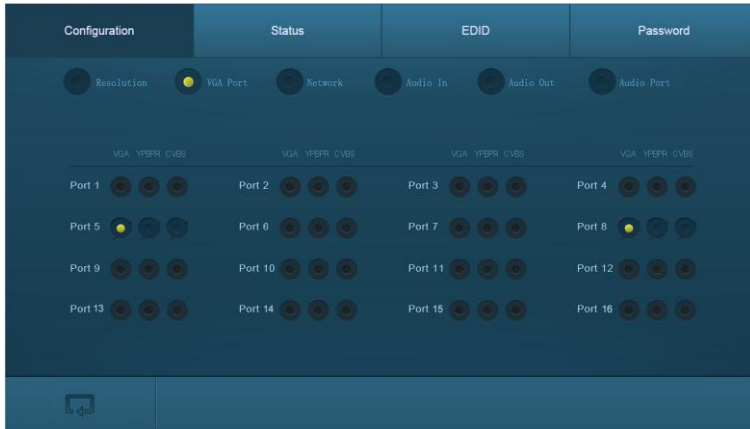

Set the VGA signal format of FMX-IUV: including VGA, YPBPR, and CVBS.

③ Configure network

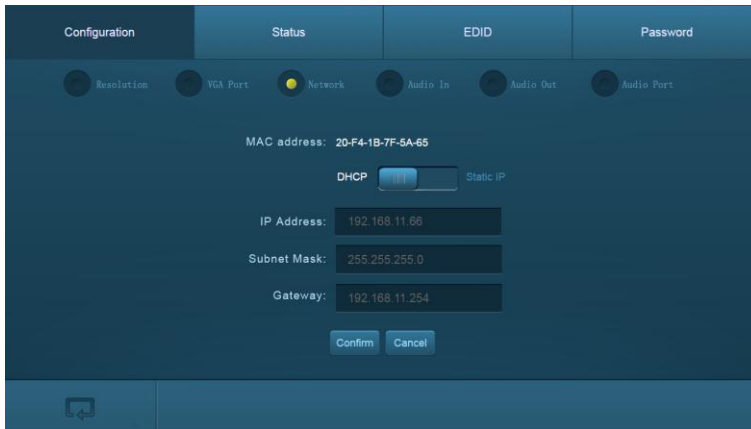

In this interface, you can set DHCP (automatically assign IP by router) or static IP (manually set IP).

④ Configure audio input

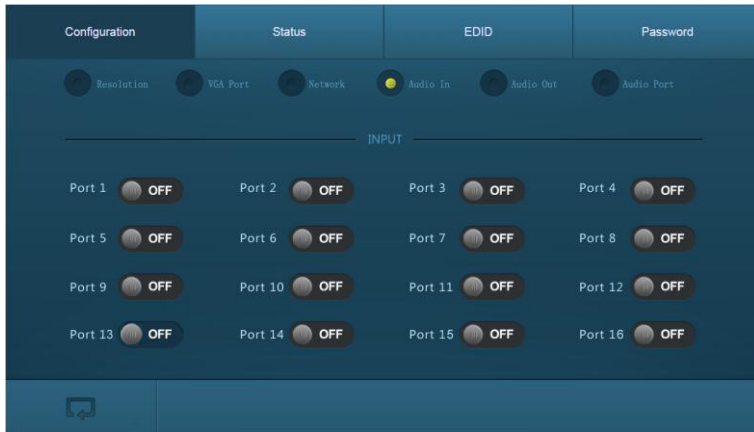

In this interface, you can switch on/ off audio input port of FMX-IUH, FMX-IBT, and FMX-IUV.

FMX-OAU: Unavailable.

⑤ Configure audio output

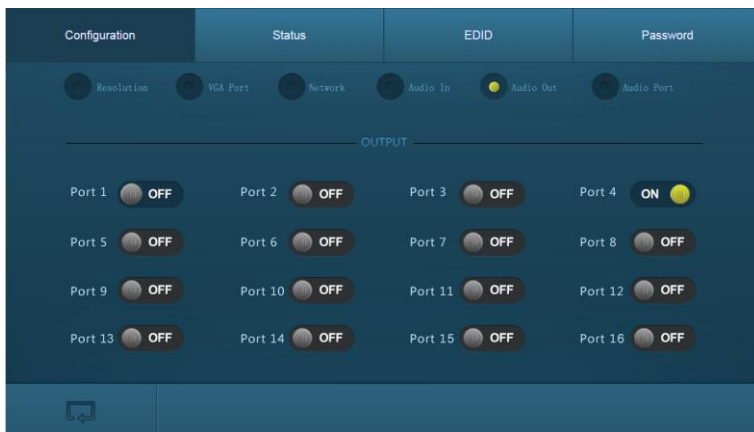

In this interface, you can switch on/ off audio output port of FMX-OUH and FMX-OBT.

FMX-OAU: Unavailable.

⑥ Configure PGM OUT audio port



In this interface, you can adjust the mixed audio volume, select stereo or mono audio channel, and select mic or line audio input.

This menu is only used for controlling the PGM port of FMX-OAU signal card.

7.3.2.2. Status

3 submenu items in total, including LCD, Button, and Scene

① Configure LCD display

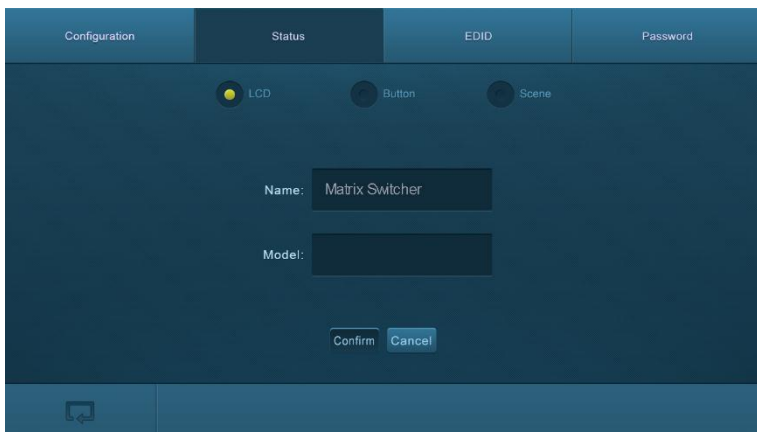

In this interface, you can configure LCD display information: max at 16 numbers/ letters.

② Set button labels

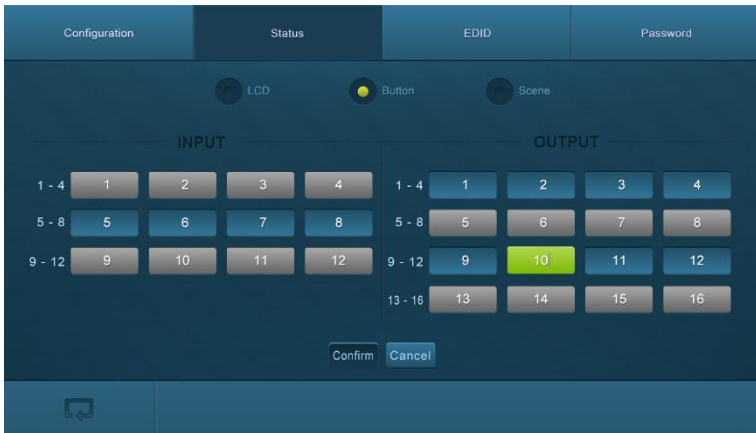

In this interface, you can set button labels: max at 7 numbers/ letters/ Chinese characters.

③ Name scene

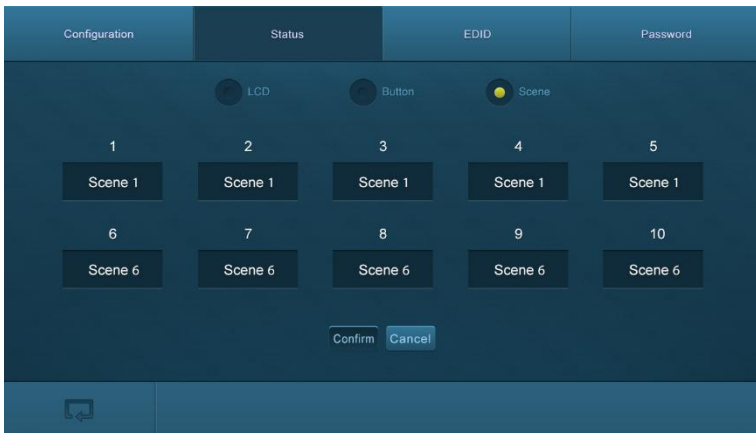

In this interface, name scenes: max at 7 numbers/ letters/ Chinese characters.

Single Plug-in Card Matrix Switcher

7.3.2.3. EDID

On EDID management interface, enable 1/all input(s) capture and learn the EDID data from 1 output.



In this interfaces, you can:

- 1 input learns EDID from 1 output: **Output + Input + Confirm**
- All inputs learn EDID from 1 output: **Output + To All Inputs**
- Undo the previous input: click **Cancel**

7.3.2.4. Password

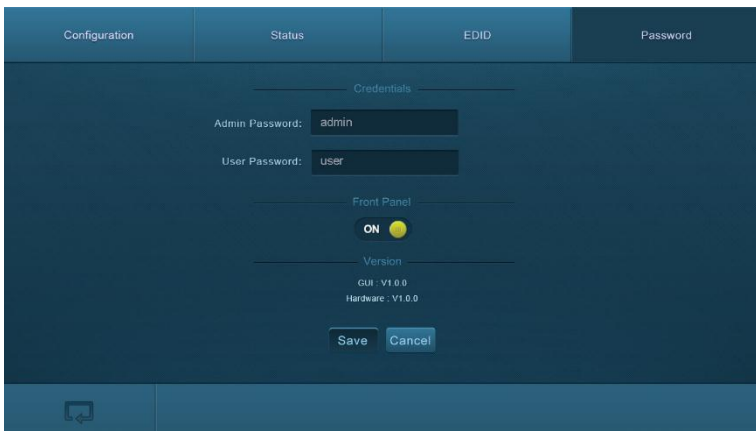



Single Plug-in Card Matrix Switcher

In this interfaces, you can:

- Set password: max at 10 numbers/ letters
- Configure front panel lock status
- Inquire GUI& Hardware versions

Remember to click **Save** to save the settings.

 Notes on the front panel icon:

Icon Status	Description
	Front panel button unlock
	Front panel button locked

Press the button to switch between the 2 states.

 Clear the cache of the browser beforehand to ensure reliable GUI operation.

7.4 Port Management

Type the designed website 192.168.0.178:100 (Default, changeable via GUI) in your browser. Enter correct username and password (same with GUI name and password) to log in the WebServer:

Here is the main configuration interface of the WebServer:

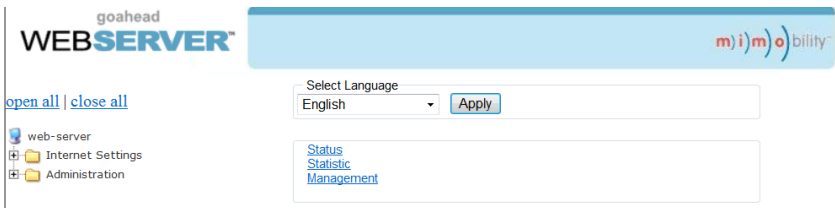

In this interface, you can:

- Change website display language.
- Modify network settings: Go to Internet Settings -> WAN.
- Upgrade TCP/IP module: Go to Administration -> Upload Program -> Select program file -> Start upgrading.
- Reboot the device after upgrading.

8. Firmware Upgrade

The switcher boasts a USB port for online firmware upgrade on the front panel. Follow these steps to upgrade firmware:

Step1. Copy the upgrade software and the latest upgrade file (.bin) to PC.

Step2. Connect the USB ports of the switcher and the PC via USB cable.

Step3. Double-click the update software icon (see as below).



It will enter the update interface shown as below:

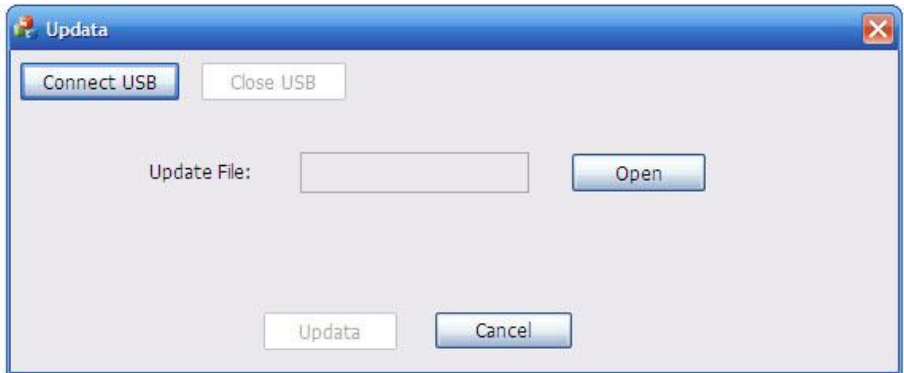

Step4. Click **Connect USB**.

Step5. Click **Open** to load the upgrade file, then click **Updata** to start firmware upgrading.

Note:

- To ensure available control, the COM number of the PC should be 1~9.
- If the update progress bar can't go on, please cut off power, and then restart this machine to update firmware again.

9. Specification

9.1 Main Unit

Connectors	
Control	(1) IR ALL IN; (1) IR EYE; (1) RS232; (1) TCP/IP
Control Connectors	(2) 3.5mm mini jack; (1) DB9; (1) RJ45
Card Slot	16 PCI-E
General	
Power Supply	100~240V AC
Power Consumption	13W (no load)
Working Temperature	0~50°C
Relative Humidity	10%~90%
Dimension (W*H*D)	483mm x 132mm x 320mm

9.2 Signal Cards

9.2.1 FMX-IUH& FMX-OUH

FMX-IUH	
Input	(1) HDMI;(1) Analog audio
Input Connector	(1) 19-pin Type A Female HDMI; (1) 3-pin pluggable terminal block
Power Consumption	4w (max)
FMX-OUH	
Output	(1) HDMI; (1) Analog audio
Output Connector	(1) 19-pin Type A Female HDMI; (1) 3-pin pluggable terminal block
Power Consumption	1.5w (max)
General	
Switching Speed	< 100ns
Standard	HDMI1.4 & HDCP2.2
Working Temperature	0~50°C
Relative Humidity	10%~90%
EDID	Supports EDID Management
Output Resolution	Auto, 4Kx2K@60Hz 4:2:0, 4Kx2K@30Hz, 1024x768@60Hz, 1920x1080p@60Hz, 1280x720@60Hz

Single Plug-in Card Matrix Switcher

9.2.2 FMX-IBT& FMX-OBT

FMX-IBT	
Input	(1) HDBT; (1) Analog audio; (1) RS232; (1) IR IN, (1) IR OUT
Input Connector	(1) Female RJ45; (2) 3-pin pluggable terminal block; (2) 3.5mm mini jack
Power Consumption	15w (max)
FMX-OBT	
Output	(1) HDBT; (1) Analog audio; (1) RS232; (1) IR IN, (1) IR OUT
Output Connector	(1) Female RJ45; (2) 3-pin pluggable terminal block; (2) 3.5mm mini jack
Power Consumption	17w (max)
General	
Transmission Distance	1080p ≤70m(Cat6); 4Kx2K ≤40m(Cat6)
Switching Speed	< 100ns
Working Temperature	0~50°C
Relative Humidity	10%~90%
Standard	HDMI2.0 & HDCP2.2
Audio	PCM
EDID	Supports EDID Management
Output Resolution	Auto, 4Kx2K@60Hz, 4Kx2K@30Hz, 1024x768@60Hz, 1920x1080p@60Hz, 1280x720@60Hz

9.2.3 FMX-IUV

Video	
Input	(1) VGA
Input Connector	(1) Female 15 pin HD
Input Resolution	Up to 1920x1200@50/60Hz
Audio	
Input	(1) Analog audio
Input Connector	(1) 3-pin pluggable terminal block
Signal Format	PCM
Frequency Response	20Hz~20KHz, ±0.5dB
CMRR	>85dB@20Hz~20KHz
General	
Power Consumption	2w (max)

Single Plug-in Card Matrix Switcher

Switching Speed	< 100ns
Working Temperature	0~50°C
Relative Humidity	10%~90%

9.2.4 FMX-OAU

Input	(1) MIC/LINE IN
Input Connector	(1) 3-pin pluggable terminal block
Output	(1) MIX OUT; (1) PGM OUT
Output Connector	(2) 3-pin pluggable terminal block
General	
Signal Format	PCM
Power Consumption	5w (max)
Frequency Response	20Hz~20KHz, ±0.5dB
CMRR	>85dB@20Hz~20KHz
Working Temperature	0~50°C
Relative Humidity	10%~90%

10. Panel Drawing

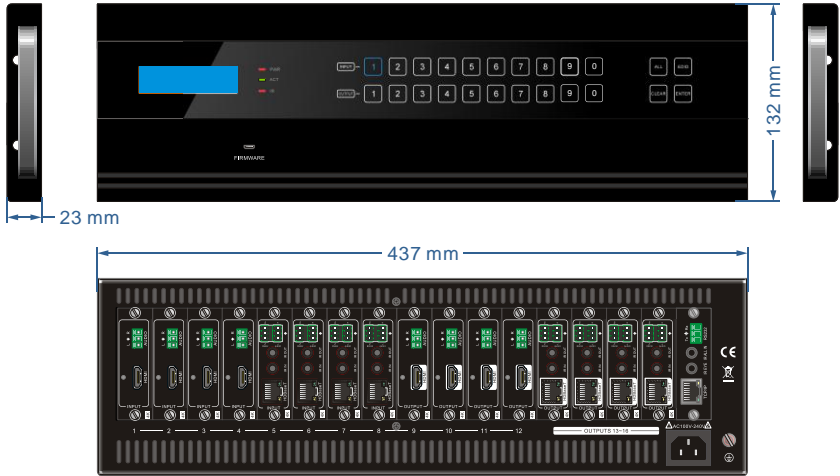

11. Troubleshooting & Maintenance

Problems	Causes	Solutions
Color losing or no video signal output in HDMI display	The connecting cables may not be connected correctly or it may be broken.	Check whether the cables are connected correctly and in working condition.
No HDMI signal output in display while local input is working normally	Loose cable connection	Reconnect the devices and make sure they're well contacted.
	The display doesn't support the resolution	Set output resolution to other supportive ones or Auto.
Splash screen in output devices	Poor quality of the connecting cable	Change for another cable of good quality.
	Poor contact at the input/output end	Reconnect the devices and make sure they're well contacted.
Cannot control the device via front panel buttons	Front panel buttons are locked	Send “/ %Unlock;” to unlock.
Cannot control the Matrix Switcher by control device (e.g. a PC) through RS232 port	Wrong RS232 communication parameters	Make sure the RS232 communication parameters are correct.
	The Matrix Switcher is broken	Send it to authorized dealer for repairing.
Static becomes stronger when connecting the video connectors	Bad grounding	Check the grounding and make sure it is connected well.

If your problem persists after following the above troubleshooting steps, seek further help from authorized dealer or our technical support.

12. Customer Service

The return of a product to our Customer Service implies the full agreement of the terms and conditions hereinafter. These terms and conditions may be changed without prior notice.

① **Warranty**

The limited warranty period of the product is fixed 3 (three) years.

② **Scope**

These terms and conditions of Customer Service apply to the customer service provided for the products or any other items sold by authorized distributor only.

③ **Warranty Exclusions:**

- Warranty expiration.
- Factory applied serial number has been altered or removed from the product.
- Damage, deterioration or malfunction caused by:
 - ✓ Normal wear and tear.
 - ✓ Use of supplies or parts not meeting our specifications.
 - ✓ No certificate or invoice as the proof of warranty.
 - ✓ The product model showed on the warranty card does not match with the model of the product for repairing or had been altered.
 - ✓ Damage caused by force majeure.
 - ✓ Servicing not authorized by distributor.
 - ✓ Any other causes which does not relate to a product defect.
- Shipping fees, installation or labor charges for installation or setup of the product.

④ **Documentation:**

Customer Service will accept defective product(s) in the scope of warranty coverage at the sole condition that the defect has been clearly defined, and upon reception of the documents or copy of invoice, indicating the date of purchase, the type of product, the serial number, and the name of distributor.

Remarks: For further assistance or solutions, please contact your local distributor.